

**FILTERS FOR POTENTIALLY  
EXPLOSIVE ATMOSPHERE**

**HYDRAULIC  
FILTRATION**

**CATALOGUE**



**MPFILTRI®**

**PASSION TO PERFORM**





## A WORLDWIDE LEADER IN THE FIELD OF HYDRAULIC FILTRATION EQUIPMENT.

Our company started life in 1964, when Bruno Pasotto decided to attempt to cater for the requests of a market still to be fully explored, with the study, design, development, production and marketing of a vast range of filters for hydraulic equipment, capable of satisfying the needs of manufacturers in all sectors. The quality of our products, our extreme competitiveness compared with major international producers and our constant activities of research, design and development has made us a worldwide leader in the field of hydraulic circuit filtering. Present for over 50 years in the market, we have played a truly decisive role in defining our sector, and by now we are a group capable of controlling our entire chain of production, monitoring all manufacturing processes to guarantee superior quality standards and to provide concrete solutions for the rapidly evolving needs of customers and the market.

# HYDRAULIC FILTRATION PRODUCTS

<b>1</b>	<b>page</b>	<b>INTRODUCTION</b>
2	INDEX	
4	COMPANY PROFILE	
8	PRODUCT RANGE	
11	CONTAMINATION MANAGEMENT	
22	FILTER SIZING	
24	CORRECTIVE FACTOR	
28	FILTER SIZING SOFTWARE	

			up to $Q_{max}$	
<b>30</b>	<b>page</b>	<b>SUCTION FILTERS</b>	<b>l/min</b>	<b>gpm</b>
33	STR & MPA - MPM	Submerged suction filter, with bypass or magnetic filter	1000	264
40	SFEX	In-line filter with plastic bowl	100	26
51	SF2 250 - 350	Semi-submerged positive head suction filter, low flow rate	160	42
59	SF2 500	Semi-submerged positive head suction filter, high flow rate	700	185
709	CLOGGING INDICATORS			

			up to $P_{max}$		up to $Q_{max}$	
<b>70</b>	<b>page</b>	<b>RETURN FILTERS</b>	<b>bar</b>	<b>psi</b>	<b>l/min</b>	<b>gpm</b>
72	RFEX	Return filter, tank mounted filter suitable for all mineral oil and water glycol applications	16	232	260	69
82	MPFX	Tank top semi-immersed filter, standard filter element disassembly	8	116	900	238
110	MPLX	Tank top semi-immersed filter, standard filter element disassembly	10	145	1800	476
118	MPTX	Tank top semi-immersed filter, easy filter element disassembly	8	116	300	79
136	MFBX	Bowl assembly	8	116	700	185
145	MPF	Tank top semi-immersed filter, standard filter element disassembly	8	116	900	238
173	MPT	Tank top semi-immersed filter, easy filter element disassembly	8	116	300	79
191	MFB	Bowl assembly	8	116	700	185
199	MDH	Heavy industrial applications integrated in the tank - air separation	10	145	500	132
207	MPH	Tank top semi-immersed filter, standard filter element disassembly	10	145	3500	925
231	MPI	Tank top semi-immersed filter, standard filter element disassembly	10	145	3500	925
243	FRI	Tank top semi-immersed filter, easy filter element disassembly, it can be used also as in-line filter	20	290	2500	660
259	RF2	Semi-immersed under-head filter, easy filter element disassembly	20	290	615	162
266	ACCESSORIES					
710	CLOGGING INDICATORS					

			up to $P_{max}$		up to $Q_{max}$	
<b>268</b>	<b>page</b>	<b>RETURN / SUCTION FILTERS</b>	<b>bar</b>	<b>psi</b>	<b>l/min</b>	<b>gpm</b>
270	MRSX	Unique TANK TOP filter for mobile machinery, with combined filtration on return and suction to the inlet at the hydrostatic transmissions in closed circuit	10	145	250	66
285	LMP 124 MULTIPORT	Unique IN-LINE filter for mobile machinery, with combined filtration on return and suction to the inlet at the hydrostatic transmissions in closed circuit	80	1160	120	32
712	CLOGGING INDICATORS					

			up to $P_{max}$		up to $Q_{max}$	
<b>292</b>	<b>page</b>	<b>SPIN-ON FILTERS</b>	<b>bar</b>	<b>psi</b>	<b>l/min</b>	<b>gpm</b>
295	MPS	Low pressure filter, available with single cartridge (CS) for in-line or flange mounting or with two cartridge on the same axis on the opposite sides	12	174	365	96
311	MSH	In-line low and medium pressure filter available with single cartridge (CH)	35	508	195	52
714	CLOGGING INDICATORS					



318 page	LOW & MEDIUM PRESSURE FILTERS	up to P <sub>max</sub>		up to Q <sub>max</sub>		
		bar	psi	l/min	gpm	
320	LFEF	In-line filter with plastic bowl	16	232	300	79
331	LMP 110	In-line low & medium pressure filter, low to medium flow rate	80	1160	165	44
339	LMP 112 - 123 MULTIPORT	In-line filter with Multiport design for multiple choice connection	80	1160	175	46
355	LMP 210 - 211	In-line low & medium pressure filter, low flow rate	60	870	365	96
365	LPH 630	Off-line low pressure filter	10	145	1600	352
373	LMP 400 - 401 & 430 - 431	In-line low & medium pressure filter, high flow rate	60	870	780	206
385	LMP 950 - 951	In-line filter, available with 2 and up to 6 different heads	30	435	2400	634
393	LMP 952 - 953 - 954	In-line low pressure filter specifically designed to be mounted in series	25	363	4500	1189
405	LMD 211	In-line duplex medium pressure filter	60	870	200	53
413	LMD 400 - 401 & 431	In-line duplex low pressure filter	16	232	600	159
429	LMD 951	In-line duplex filter, available with 2 up to 6 different heads	16	232	1200	317
437		Filter elements designed according to DIN 24550				
439	LDP - LDD	In-line and duplex medium pressure filter	60	870	360	95
449	LMP 900 - 901	In-line low pressure filter	30	435	2000	528
457	LMP 902 - 903	In-line filter specifically designed to be mounted in series	20	290	3000	793
466	ACCESSORIES					
716	CLOGGING INDICATORS					

468 page	HIGH PRESSURE FILTERS	up to P <sub>max</sub>		up to Q <sub>max</sub>		
		bar	psi	l/min	gpm	
470	FMMX 050	Typical high pressure filter for mobile applications, low flow rate	420	6092	154	41
479	FMM	Typical high pressure filter for mobile applications, low flow rate	420	6092	300	79
489	FHA 051	Filter optimized for use in high pressure operating systems, low flow rate	560	8122	150	40
497	FMP 039	Filter high pressure, low flow rate applications	110	1595	80	21
505	FMP	Filter high pressure, high flow rate applications	320	4641	500	132
517	FHP	Typical high pressure filter for mobile applications, high flow rate	450	6527	630	166
537	FHM	High pressure filter with intermediate manifold construction	320	4641	400	106
555	FHB	High pressure for block mounting	320	4641	485	128
569	FHF 325	In-line manifold top mounting	350	5076	550	145
579	FHD	In-line duplex high pressure filter	350	5076	250	66
593	HPB	Pressure filter kits for integration in control manifolds	420	6092	300	79
717	CLOGGING INDICATORS					

602 page	STAINLESS STEEL HIGH PRESSURE FILTERS	up to P <sub>max</sub>		up to Q <sub>max</sub>		
		bar	psi	l/min	gpm	
605	FZP	In-line pressure filter with threaded mount	420	6092	160	42
615	FZH	In-line pressure filter with threaded mount for higher pressure	700	10153	80	21
625	FZX	In-line pressure filter with threaded mount up to 1000 bar	1000	14504	10	3
633	FZM	Manifold top mounting	320	4641	70	18
641	FZB	Manifold side mounting	320	4641	70	18
649	FZD	Duplex pressure filter for continuous operation requirements	350	5076	60	16
718	CLOGGING INDICATORS					

660 page	FILTERS FOR POTENTIALLY EXPLOSIVE ATMOSPHERE	up to P <sub>max</sub>		up to Q <sub>max</sub>		
		bar	psi	l/min	gpm	
663	FMMX 050	Typical high pressure filter for mobile applications, low flow rate	420	6092	154	41
671	FZP	In-line pressure filter with threaded mount	700	10153	80	21
681	FZH	In-line pressure filter with threaded mount for higher pressure	1000	14504	10	3
691	FZX	In-line pressure filter with threaded mount up to 1000 bar	320	4641	70	18
719	CLOGGING INDICATORS					

699 page	CLOGGING INDICATORS
704	QUICK REFERENCE GUIDE
708	DESIGNATION AND ORDERING CODES
720	TECHNICAL DATA

## MARKET LEADER



Our work is based on a skillful interaction between advanced technology and fine workmanship, **customizing products according to specific market requests**, focusing strongly on innovation and quality, and following every step in the manufacturing of both standard and special products, fully respecting customer expectations.



Our customer-oriented philosophy, which enables us to satisfy all customer requests **rapidly and with personalized products**, makes us a **dynamic and flexible enterprise**. The possibility of constantly controlling and monitoring the entire production process is essential to allow us to guarantee the quality of our products.

## WORLDWIDE PRESENCE

Our foreign Branches enable us to offer a diversified range of products that allow us to successfully face the aggressive challenge of international competition, and also to maintain a stable presence at a local level.

The Group boasts **9** business branches



## TECHNOLOGY

Our constant **quest for excellence in quality and technological innovation** allows us to offer only the best solutions and services for applications in many fields, including general industry, test rigs, lubrication, heavy engineering, renewable energies, naval engineering, offshore engineering, aviation systems, emerging technologies and mobile plant (i.e. tractors, excavators, concrete pumps, platforms).





## AND PRODUCTION

Our high level of technological expertise means **we can rely entirely on our own resources, without resorting to external providers.** This in turn enables us to satisfy a growing number of customer requests, also exploiting our constantly updated range of machines and equipment, featuring **fully-automated workstations** capable of **24-hour production.**

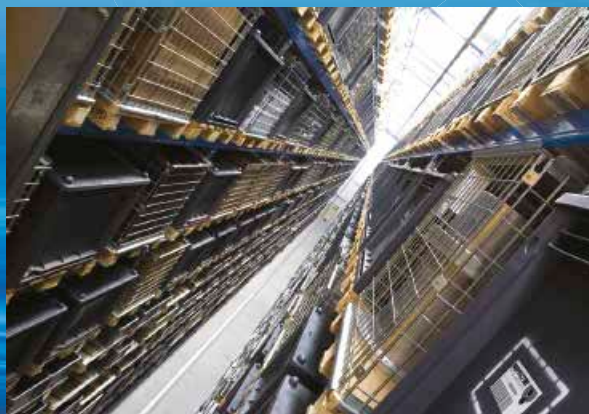



### SUCTION FILTERS

Flow rates  
up to 875 l/min

- Mounting:
- Tank immersed
  - In-Line
  - In tank with shut off valve
  - In tank with flooded suction

### RETURN FILTERS

Flow rates  
up to 3000 l/min

- Pressure  
up to 20 bar
- Mounting:
- In-Line
  - Tank top
  - In single and duplex designs

### RETURN / SUCTION FILTERS

Flow rates  
up to 300 l/min

- Pressure  
up to 80 bar
- Mounting:
- In-Line
  - Tank top

### SPIN-ON FILTERS

Flow rates  
up to 365 l/min

- Pressure  
up to 35 bar
- Mounting:
- In-Line
  - Tank top

### LOW & MEDIUM PRESSURE FILTERS

Flow rates  
up to 3000 l/min

- Pressure  
up to 80 bar
- Mounting:
- In-Line
  - Parallel manifold version
  - In single and duplex designs

### HIGH PRESSURE FILTERS

Flow rates  
up to 750 l/min

- Pressure from 110 bar  
up to 560 bar
- Mounting:
- In-Line
  - Manifold
  - In single and duplex designs

# PRODUCT RANGE

MP Filtri can offer a vast and articulated range of products for the global market, suitable for all industrial sectors using hydraulic equipment.

This includes filters (suction, return, return/suction, spin-on, pressure, stainless steel pressure, ATEX filters) and structural components (motor/pump bell-housings, transmission couplings, damping rings, foot brackets, aluminium tanks, cleaning covers).

We can provide all the skills and solutions required by the modern hydraulics industry to monitor contamination levels and other fluid conditions.

Mobile filtration units and a full range of accessories allow us to supply everything necessary for a complete service in the hydraulic circuits.



## STAINLESS STEEL HIGH PRESSURE FILTERS

Flow rates up to 150 l/min

Pressure from 320 bar up to 1000 bar

- Mounting:
- In-Line
  - Manifold
  - In single and duplex designs

## FILTERS FOR POTENTIALLY EXPLOSIVE ATMOSPHERE

Flow rates up to 154 l/min

Pressure from 420 bar up to 1000 bar

- Mounting:
- In-Line

## CONTAMINATION CONTROL SOLUTIONS

- Off-line, in-line particle counters
- Off-line bottle sampling products
- Fully calibrated using relevant ISO standards
- A wide range of variants to support fluid types and communication protocols
- Mobile Filtration Units with flow rates from 15 l/min up to 200 l/min

## POWER TRANSMISSION PRODUCTS

- Aluminium bell-housings for motors from 0.12 kW to 400 kW
- Couplings in Aluminium Cast Iron - Steel
- Damping rings
- Foot bracket
- Aluminium tanks
- Cleaning covers

## TANK ACCESSORIES

- Oil filler and air breather plugs
- Optical and electrical level gauges
- Pressure gauge valve selectors
- Pipe fixing brackets
- Pressure gauges

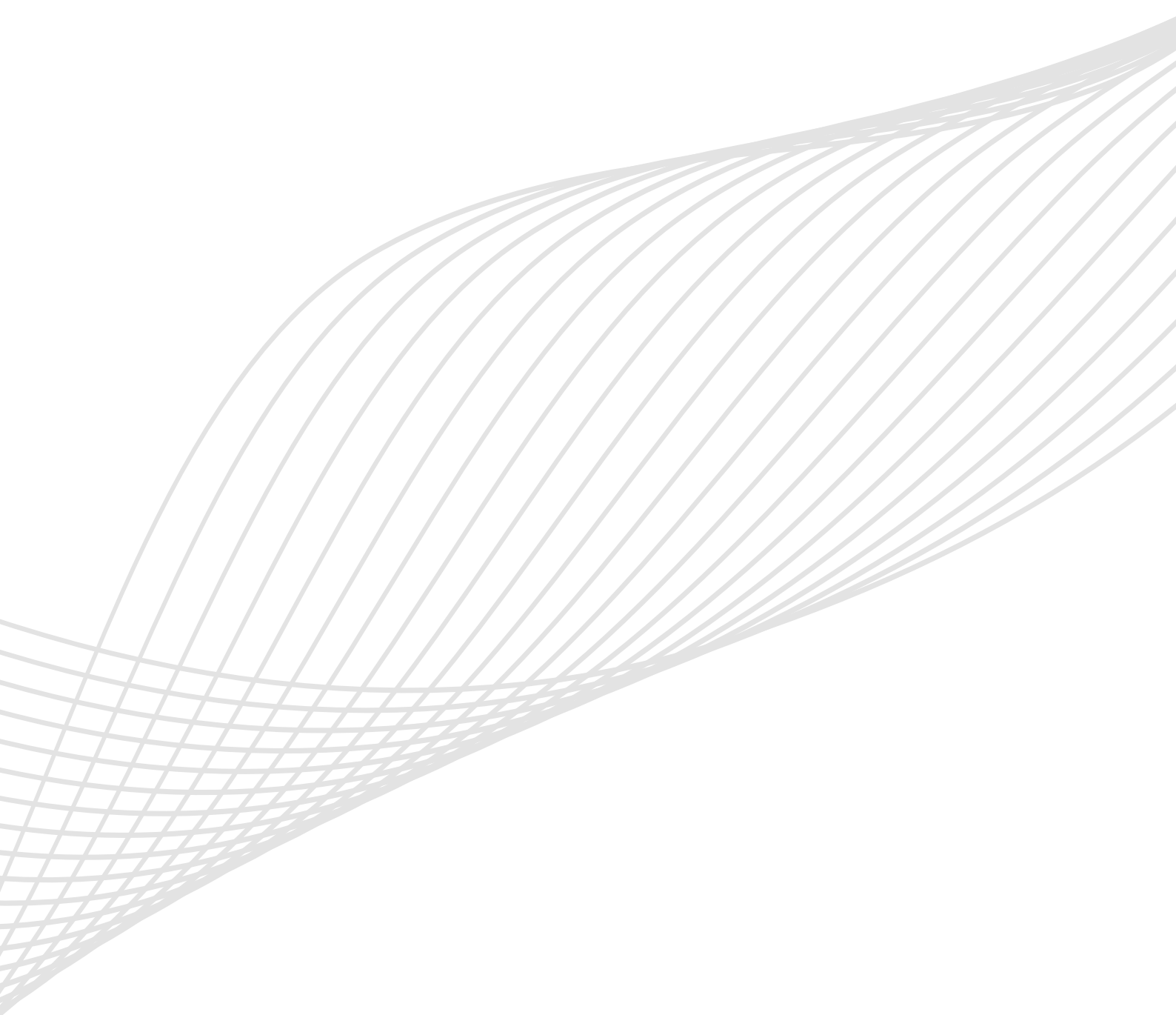



# CONTAMINATION MANAGEMENT

## INDEX

	Page
① HYDRAULIC FLUIDS	12
② FLUIDS CONTAMINATION	12
③ FLUIDS COMPATIBILITY CHART	12
④ EFFECTS OF CONTAMINATION ON HYDRAULIC COMPONENTS	13
⑤ MEASURING THE SOLID CONTAMINATION LEVEL	13
⑥ FILTRATION TECHNOLOGIES	16
⑦ RECOMMENDED CONTAMINATION CLASSES	17
⑧ TYPES OF FILTERS	17
⑨ FILTER SIZING PARAMETERS	18
⑩ APPLICABLE STANDARDS FOR FILTER DEVELOPMENT	18
⑪ WATER IN HYDRAULIC AND LUBRICATING FLUIDS	19
⑫ THE ANTI-STATIC FILTERS <b>zerospark+</b>	20

## 1 HYDRAULIC FLUIDS

The fluid is the vector that transmits power, energy within an oleodynamic circuit. In addition to transmitting energy through the circuit, it also performs additional functions such as lubrication, protection and cooling of the surfaces.

The classification of fluids used in hydraulic systems is coded in many regulatory references, different Standards.

The most popular classification criterion divides them into the following families:

- MINERAL OILS

Commonly used oil derived fluids.

- FIRE RESISTANT FLUIDS

Fluids with intrinsic characteristics of incombustibility or high flash point.

- SYNTHETIC FLUIDS

Modified chemical products to obtain specific optimized features.

- ECOLOGICAL FLUIDS

Synthetic or vegetable origin fluids with high biodegradability characteristics.

The choice of fluid for an hydraulic system must take into account several parameters.

These parameters can adversely affect the performance of an hydraulic system, causing delay in the controls, pump cavitation, excessive absorption, excessive temperature rise, efficiency reduction, increased drainage, wear, jam/block or air intake in the plant.

The main properties that characterize hydraulic fluids and affect their choice are:

- DYNAMIC VISCOSITY

It identifies the fluid's resistance to sliding due to the impact of the particles forming it.

- KINEMATIC VISCOSITY

It is a widespread formal dimension in the hydraulic field.

It is calculated with the ratio between the dynamic viscosity and the fluid density.

Kinematic viscosity varies with temperature and pressure variations.

- VISCOSITY INDEX

This value expresses the ability of a fluid to maintain viscosity when the temperature changes.

A high viscosity index indicates the fluid's ability to limit viscosity variations by varying the temperature.

- FILTERABILITY INDEX

It is the value that indicates the ability of a fluid to cross the filter materials. A low filterability index could cause premature clogging of the filter material.

- WORKING TEMPERATURE

Working temperature affects the fundamental characteristics of the fluid. As already seen, some fluid characteristics, such as cinematic viscosity, vary with the temperature variation.

When choosing a hydraulic oil, must therefore be taken into account of the environmental conditions in which the machine will operate.

- COMPRESSIBILITY MODULE

Every fluid subjected to a pressure contracts, increasing its density.

The compressibility module identifies the increase in pressure required to cause a corresponding increase in density.

- HYDROLYTIC STABILITY

It is the characteristic that prevents galvanic pairs that can cause wear in the plant/system.

- ANTIOXIDANT STABILITY AND WEAR PROTECTION

These features translate into the capacity of a hydraulic oil to avoid corrosion of metal elements inside the system.

- HEAT TRANSFER CAPACITY

It is the characteristic that indicates the capacity of hydraulic oil to exchange heat with the surfaces and then cool them.

## 2 FLUID CONTAMINATION

Whatever the nature and properties of fluids, they are inevitably subject to contamination. Fluid contamination can have two origins:

- INITIAL CONTAMINATION

Caused by the introduction of contaminated fluid into the circuit, or by incorrect storage, transport or transfer operations.

- PROGRESSIVE CONTAMINATION

Caused by factors related to the operation of the system, such as metal surface wear, sealing wear, oxidation or degradation of the fluid, the introduction of contaminants during maintenance, corrosion due to chemical or electrochemical action between fluid and components, cavitation. The contamination of hydraulic systems can be of different nature:

- SOLID CONTAMINATION

For example rust, slag, metal particles, fibers, rubber particles, paint particles or additives

- LIQUID CONTAMINATION

For example, the presence of water due to condensation or external infiltration or acids

- GASEOUS CONTAMINATION

For example, the presence of air due to inadequate oil level in the tank, drainage in suction ducts, incorrect sizing of tubes or tanks.

## 3 FLUID COMPATIBILITY CHARTS

For general fluid compatibility with Contamination Monitoring Products the below rules can be used:

- For mineral oils, synthetic fluids and diesel - the 'M' type variant of unit is recommended.

- For water based/ subsea fluids & 'M' type fluids - the 'N' type variant of unit is recommended.

- For Aerospace phosphate esters, Skydrols® and aggressive fluids along with 'M' & 'N' type fluids - the 'S' type variant is recommended.

**All fluids are required to be clear in appearance to allow light to penetrate unhindered.**



For further and more detailed information on specific fluid compatibility please refer to the fluid compatibility list

## ④ EFFECTS OF CONTAMINATION ON HYDRAULIC COMPONENTS

Solid contamination is recognized as the main cause of malfunction, failure and early degradation in hydraulic systems. It is impossible to delete it completely, but it can be effectively controlled by appropriate devices.

CONTAMINATION IN PRESENCE OF LARGE TOLERANCES



CONTAMINATION IN PRESENCE OF NARROW TOLERANCES



Solid contamination mainly causes surface damage and component wear.

- ABRASION OF SURFACES  
Cause of leakage through mechanical seals, reduction of system performance, failures.
- SURFACE EROSION  
Cause of leakage through mechanical seals, reduction of system performance, variation in adjustment of control components, failures.
- ADHESION OF MOVING PARTS  
Cause of failure due to lack of lubrication.
- DAMAGES DUE TO FATIGUE  
Cause of breakdowns and components breakdown.

ABRASION



EROSION



ADHESION

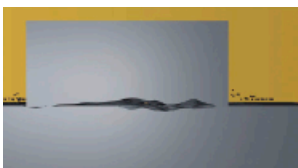

FATIGUE



Liquid contamination mainly results in decay of lubrication performance and protection of fluid surfaces.

### DISSOLVED WATER

- INCREASING FLUID ACIDITY  
Cause of surface corrosion and premature fluid oxidation
- GALVANIC COUPLE AT HIGH TEMPERATURES  
Cause of corrosion

### FREE WATER - ADDITIONAL EFFECTS

- DECAY OF LUBRICANT PERFORMANCE  
Cause of rust and sludge formation, metal corrosion and increased solid contamination
- BATTERY COLONY CREATION  
Cause of worsening in the filterability feature

- ICE CREATION AT LOW TEMPERATURES  
Cause damage to the surface
- ADDITIVE DEPLETION  
Free water retains polar additives

Gaseous contamination mainly results in decay of system performance.

- CUSHION SUSPENSION  
Cause of increased noise and cavitation.
- FLUID OXIDATION  
Cause of corrosion acceleration of metal parts.
- MODIFICATION OF FLUID PROPERTIES (COMPRESSIBILITY MODULE, DENSITY, VISCOSITY)  
Cause of system's reduction of efficiency and of control. It is easy to understand how a system without proper contamination management is subject to higher costs than a system that is provided.
- MAINTENANCE  
Increase maintenance activities, spare parts, machine stop costs.
- ENERGY AND EFFICIENCY  
Efficiency and performance reduction due to friction, drainage, cavitation.

## ⑤ MEASURING THE SOLID CONTAMINATION LEVEL

The level of contamination of a system identifies the amount of contaminant contained in a fluid. This parameter refers to a unit volume of fluid. The level of contamination may be different at different points in the system. From the information in the previous paragraphs it is also apparent that the level of contamination is heavily influenced by the working conditions of the system, by its working years and by the environmental conditions.

What is the size of the contaminating particles that we must handle in our hydraulic circuit?

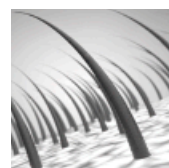

HUMAN HAIR (75 µm)

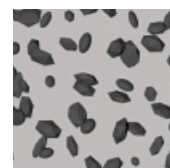

MINIMUM DIMENSION VISIBLE WITH HUMAN EYES (40 µm)

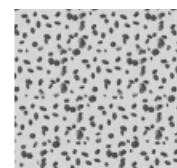

TYPICAL CONTAMINANT DIMENSION IN A HYDRAULIC CIRCUIT (4 - 14 µm)

Contamination level analysis is significant only if performed with a uniform and repeatable method, conducted with standard test methods and suitably calibrated equipment. To this end, ISO has issued a set of standards that allow tests to be conducted and express the measured values in the following ways.

- GRAVIMETRIC LEVEL - ISO 4405

The level of contamination is defined by checking the weight of particles collected by a laboratory membrane. The membrane must be cleaned, dried and desiccated, with fluid and conditions defined by the Standard. The volume of fluid is filtered through the membrane by using a suitable suction system. The weight of the contaminant is determined by checking the weight of the membrane before and after the fluid filtration.



CLEAN MEMBRANE

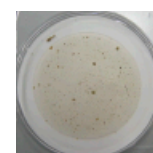

CONTAMINATED MEMBRANE

# CONTAMINATION MANAGEMENT

## - CUMULATIVE DISTRIBUTION OF THE PARTICLES SIZE - ISO 4406

The level of contamination is defined by counting the number of particles of certain dimensions per unit of volume of fluid. Measurement is performed by Contamination Monitoring Products (CMP).

Following the count, the contamination classes are determined, corresponding to the number of particles detected in the unit of fluid.

The most common classification methods follow ISO 4406 and SAE AS 4059 (Aerospace Sector) regulations.

NAS 1638 is still used although obsolete.

### Classification example according to ISO 4406

The International Standards Organization standard ISO 4406 is the preferred method of quoting the number of solid contaminant particles in a sample. The level of contamination is defined by counting the number of particles of certain dimensions per unit of volume of fluid. The measurement is performed by Contamination Monitoring Products (CMP).

The numbers represent a code which identifies the number of particles of certain sizes in 1ml of fluid. Each code number has a particular size range. The first scale number represents the number of particles equal to or larger than 4  $\mu\text{m}_{(c)}$  per millilitre of fluid; The second scale number represents the number of particles equal to or larger than 6  $\mu\text{m}_{(c)}$  per millilitre of fluid; The third scale number represents the number of particles equal to or larger than 14  $\mu\text{m}_{(c)}$  per millilitre of fluid.

ISO 4406 - Allocation of Scale Numbers

Class	Number of particles per ml	
	Over	Up to
28	1 300 000	2 500 000
27	640 000	1 300 000
26	320 000	640 000
25	160 000	320 000
24	80 000	160 000
23	40 000	80 000
22	20 000	40 000
21	10 000	20 000
20	5 000	10 000
19	2 500	5 000
18	1 300	2 500
17	640	1 300
16	320	640
15	160	320
14	80	160
13	40	80
12	20	40
11	10	20
10	5	10
9	2.5	5
8	1.3	2.5
7	0.64	1.3
6	0.32	0.64
5	0.16	0.32
4	0.08	0.16
3	0.04	0.08
2	0.02	0.04
1	0.01	0.02
0	0	0.01

- > 4  $\mu\text{m}_{(c)}$  = 350 particles
  - > 6  $\mu\text{m}_{(c)}$  = 100 particles
  - > 14  $\mu\text{m}_{(c)}$  = 25 particles
- 16 / 14 / 12

### ISO 4406 Cleanliness Code System

Microscope counting examines the particles differently to Contamination Monitoring Products (CMP) and the code is given with two scale numbers only. These are at 5  $\mu\text{m}$  and 15  $\mu\text{m}$  equivalent to the 6  $\mu\text{m}_{(c)}$  and 14  $\mu\text{m}_{(c)}$  of Contamination Monitoring Products (CMP).

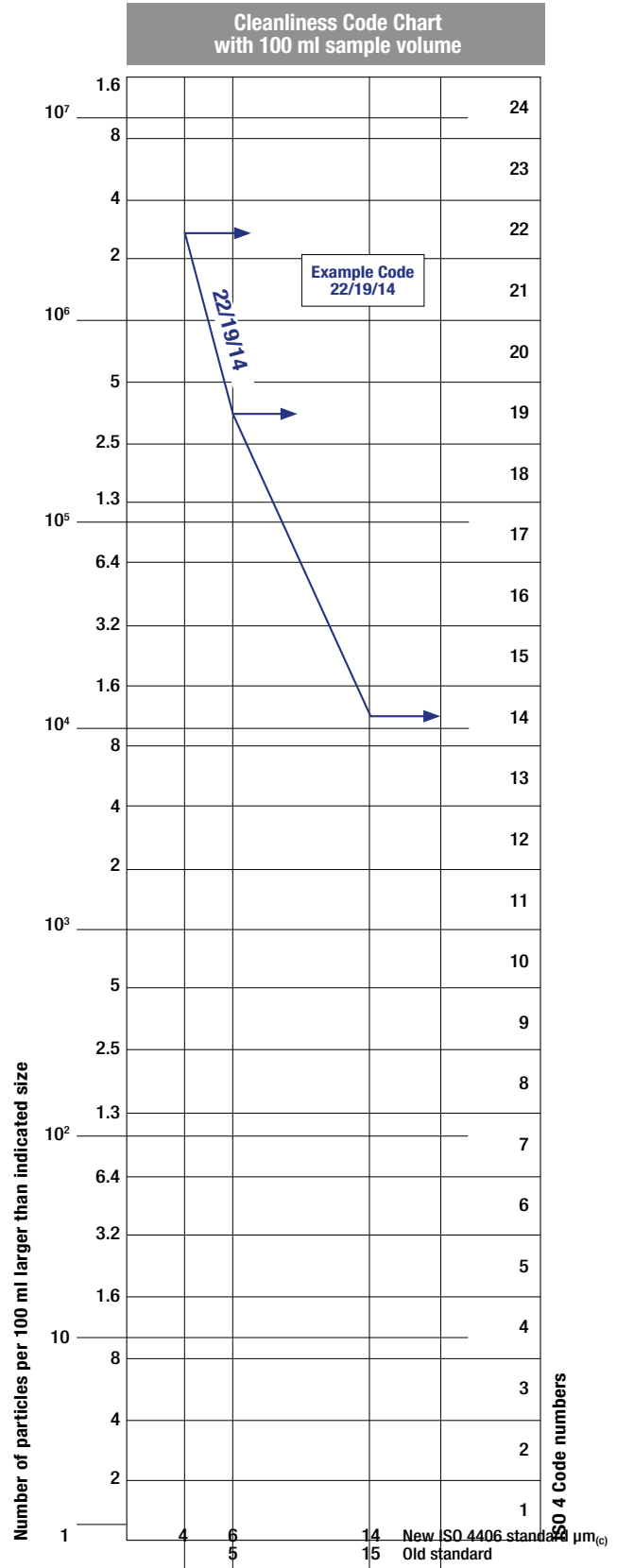

- CUMULATIVE DISTRIBUTION OF THE PARTICLES SIZE  
SAE AS4059-1 and SAE AS4059-2

### Classification example according to SAE AS4059 - Rev. G

The code, prepared for the aerospace industry, is based on the size, quantity, and particle spacing in a 100 ml fluid sample. The contamination classes are defined by numeric codes, the size of the contaminant is identified by letters (A-F).

This SAE Aerospace Standard (AS) defines cleanliness levels for particulate contamination of hydraulic fluids and includes methods of reporting data relating to the contamination levels. Tables 1 and 2 below provide differential and cumulative particle counts respectively for counts obtained by an automatic particle counter, e.g. LPA3.

Table 1 - Class for differential measurement

Class	Dimension of contaminant Maximum Contamination Limits per 100 ml (3)				
	5-15 µm	15-25 µm	25-50 µm	50-100 µm	>100 µm (1)
	6-14 µm(c)	14-21 µm(c)	21-38 µm(c)	38-70 µm(c)	>70 µm(c) (2)
00	125	22	4	1	0
0	250	44	8	2	0
1	500	89	16	3	1
2	1 000	178	32	6	1
3	2 000	356	63	11	2
4	4 000	712	126	22	4
5	8 000	1 425	253	45	8
6	16 000	2 850	506	90	16
7	32 000	5 700	1 012	180	32
8	64 000	11 400	2 025	360	64
9	128 000	22 800	4 050	720	128
10	256 000	45 600	8 100	1 440	256
11	512 000	91 200	16 200	2 880	512
12	1 024 000	182 400	32 400	5 760	1 024

6 - 14 µm(c) = 15 000 particles
14 - 21 µm(c) = 2 200 particles
21 - 38 µm(c) = 200 particles
38 - 70 µm(c) = 35 particles
> 70 µm(c) = 3 particles
SAE AS4059 REV G - Class 6

(1) Size range, optical microscope, based on longest dimension as measured per AS598 or ISO 4407. (2) Size range CMP calibrated per ISO 11171 or an optical or electron microscope with image analysis software, based on projected area equivalent diameter. (3) Contamination classes and particle count limits are identical to NAS 1638.

Table 2 - Class for cumulative measurement

Class	Dimension of contaminant Maximum Contamination Limits per 100 ml					
	>1 µm	>5 µm	>15 µm	>25 µm	>50 µm	>100 µm (1)
	>4 µm(c)	>6 µm(c)	>14 µm(c)	>21 µm(c)	>38 µm(c)	>70 µm(c) (2)
000	195	76	14	3	1	0
00	390	152	27	5	1	0
0	780	304	54	10	2	0
1	1 560	609	109	20	4	1
2	3 120	1 217	217	39	7	1
3	6 250	2 432	432	76	13	2
4	12 500	4 864	864	152	26	4
5	25 000	9 731	1 731	306	53	8
6	50 000	19 462	3 462	612	106	16
7	100 000	38 924	6 924	1 224	212	32
8	200 000	77 849	13 849	2 449	424	64
9	400 000	155 698	27 698	4 898	848	128
10	800 000	311 396	55 396	9 796	1 696	256
11	1 600 000	622 792	110 792	19 592	3 392	512
12	3 200 000	1 245 584	221 584	39 184	6 784	1 024

> 4 µm(c) = 45 000 particles
> 6 µm(c) = 15 000 particles
> 14 µm(c) = 1 500 particles
> 21 µm(c) = 250 particles
> 38 µm(c) = 15 particles
> 70 µm(c) = 3 particle
SAE AS4059 REV G cpc* Class 6 6/6/5/5/4/2

(1) Size range, optical microscope, based on longest dimension as measured per AS598 or ISO 4407. (2) Size range, CMP calibrated per ISO 11171 or an optical or electron microscope with image analysis software, based on projected area equivalent diameter. (3) Contamination classes and particle count limits are identical to NAS 1638.

\* cumulative particle count

- CLASSES OF CONTAMINATION ACCORDING TO NAS 1638 (January 1964)

The NAS system was originally developed in 1964 to define contamination classes for the contamination contained within aircraft components.

The application of this standard was extended to industrial hydraulic systems simply because nothing else existed at the time.

The coding system defines the maximum numbers permitted of 100 ml volume at various size intervals (differential counts) rather than using cumulative counts as in ISO 4406. Although there is no guidance given in the standard on how to quote the levels, most industrial users quote a single code which is the highest recorded in all sizes and this convention is used on MP Filtri Contamination Monitoring Products (CMP).

The contamination classes are defined by a number (from 00 to 12) which indicates the maximum number of particles per 100 ml, counted on a differential basis, in a given size bracket.

Size Range Classes (in microns)

Class	Maximum Contamination Limits per 100 ml				
	5-15	15-25	25-50	50-100	>100
	5-15 µm	15-25 µm	25-50 µm	50-100 µm	>100 µm
00	125	22	4	1	0
0	250	44	8	2	0
1	500	89	16	3	1
2	1 000	178	32	6	1
3	2 000	356	63	11	2
4	4 000	712	126	22	4
5	8 000	1 425	253	45	8
6	16 000	2 850	506	90	16
7	32 000	5 700	1 012	180	32
8	64 000	11 400	2 025	360	64
9	128 000	22 800	4 050	720	128
10	256 000	45 600	8 100	1 440	256
11	512 000	91 200	16 200	2 880	512
12	1 024 000	182 400	32 400	5 760	1 024

5-15 µm = 42 000 particles
15-25 µm = 2 200 particles
25-50 µm = 150 particles
50-100 µm = 18 particles
> 100 µm = 3 particles
Class NAS 8

- CUMULATIVE DISTRIBUTION OF THE PARTICLES SIZE - ISO 4407

The level of contamination is defined by counting the number of particles collected by a laboratory membrane per unit of fluid volume. The measurement is done by a microscope. The membrane must be cleaned, dried and desiccated, with fluid and conditions defined by the Standard. The fluid volume is filtered through the membrane, using a suitable suction system.

The level of contamination is identified by dividing the membrane into a predefined number of areas and by counting the contaminant particles using a suitable laboratory microscope.

MICROSCOPE CONTROL AND MEASUREMENT



Example figure 1 and 2

COMPARISON PHOTOGRAPHS  
1 graduation = 10µm



Fig. 1



Fig. 2

For other comparison photographs for contamination classes see the "Fluid Condition and Filtration Handbook".



## - CLEANLINESS CODE COMPARISON

Although ISO 4406 standard is being used extensively within the hydraulics industry other standards are occasionally required and a comparison may be requested. The table below gives a very general comparison but often no direct comparison is possible due to the different classes and sizes involved.

ISO 4406	SAE AS4059 Table 2	SAE AS4059 Table 1	NAS 1638
> 4 $\mu\text{m}_{(c)}$ 6 $\mu\text{m}_{(c)}$ 14 $\mu\text{m}_{(c)}$	> 4 $\mu\text{m}_{(c)}$ 6 $\mu\text{m}_{(c)}$ 14 $\mu\text{m}_{(c)}$	4-6 6-14 14-21 21-38 38-70 >70	5-15 15-25 25-50 50-100 >100
23 / 21 / 18	13A / 12B / 12C	12	12
22 / 20 / 17	12A / 11B / 11C	11	11
21 / 19 / 16	11A / 10B / 10C	10	10
20 / 18 / 15	10A / 9B / 9B	9	9
19 / 17 / 14	9A / 8B / 8C	8	8
18 / 16 / 13	8A / 7B / 7C	7	7
17 / 15 / 12	7A / 6B / 6C	6	6
16 / 14 / 11	6A / 5B / 5C	5	5
15 / 13 / 10	5A / 4B / 4C	4	4
14 / 12 / 09	4A / 3B / 3C	3	3

## 6 FILTRATION TECHNOLOGIES

Various mechanisms such as mechanical stoppage, magnetism, gravimetric deposit, or centrifugal separation can be used to reduce the level of contamination.

The mechanical stoppage method is most effective and can take place in two ways:

### - SURFACE FILTRATION

It is by direct interception. The filter prevents particles larger than the pores from continuing in the plant / system. Surface filters are generally manufactured with metal canvases or meshes.

### - DEPTH FILTERING

Filters are constructed by fiber interlacing. Such wraps form pathways of different shapes and sizes in which the particles remain trapped when they find smaller apertures than their diameter.

Depth filters are generally produced with papers impregnated with phenolic resins, metal fibers or inorganic fibers.

In inorganic fiber filtration, commonly called microfibre, the filtering layers are often overlapped in order to increase the ability to retain the contaminant.

WIRE MESH FILTRATION

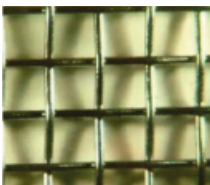

PAPER FILTRATION

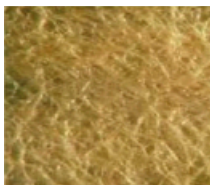

MICROFIBER FILTRATION

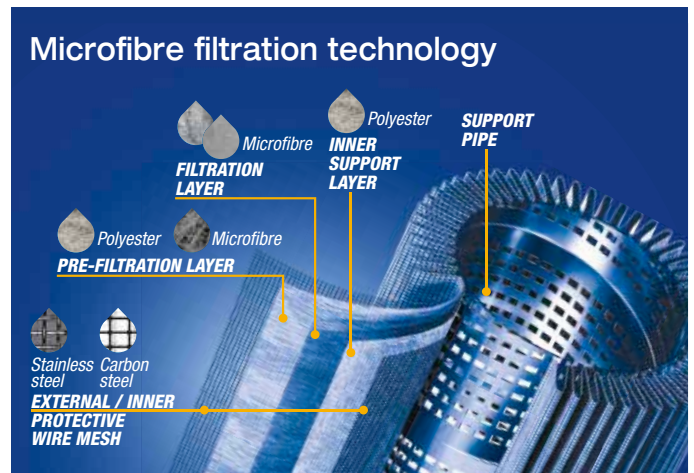
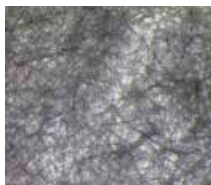

The filtration efficiency of metallic mesh filtrations is defined as the maximum particle size that can pass through the meshes of the filtering grid.

The efficiency of microfibre and paper filtration ( $\beta_{x(c)}$ ) is defined through a lab test called Multipass Test. The efficiency value ( $\beta_{x(c)}$ ) is defined as the ratio between the number of particles of certain dimensions detected upstream and downstream of the filter.

$$\frac{\text{Upstream particles number} > X \mu\text{m}_{(c)}}{\text{Downstream particles number} > X \mu\text{m}_{(c)}} = \beta_{x(c)}$$



Value ( $\beta_{x(c)}$ )	2	10	75	100	200	1000
Efficiency	50%	90%	98.7%	99%	99.5%	99.9%

Test conditions, such as type of fluid to be used (MIL-H-5606), type of contaminant to be used (ISO MTD), fluid viscosity, test temperature, are determined by ISO 16889.

In addition to the filtration efficiency value during the Multipass test, other important features, such as filtration stability ( $\beta$  stability) and dirt holding capacity (DHC), are also tested.

Poor filtration stability is the cause of the filtering quality worsening as the filter life rises. Low dirt holding capacity causes a reduction in the life of the filter.

Filtration ISO Standard Comparison

$\beta_{x(c)} > 1000$ ISO 16889	$\beta_x > 200$ ISO 4572	MP Filtri Filter media code
5 $\mu\text{m}_{(c)}$	3 $\mu\text{m}$	A03
7 $\mu\text{m}_{(c)}$	6 $\mu\text{m}$	A06
10 $\mu\text{m}_{(c)}$	10 $\mu\text{m}$	A10
16 $\mu\text{m}_{(c)}$	18 $\mu\text{m}$	A16
21 $\mu\text{m}_{(c)}$	25 $\mu\text{m}$	A25

## 7 RECOMMENDED CONTAMINATION CLASSES

Any are the nature and the properties of fluids, they are inevitably subject to contamination. The level of contamination can be managed by using special components called filters.

Hydraulic components builders, knowing the problem of contamination, recommend the filtration level appropriate to the use of their products.

Example of recommended contamination levels for pressures below 140 bar.

Piston pumps with fixed flow rate	•					
Piston pumps with variable flow rate			•			
Vane pumps with fixed flow rate		•				
Vane pumps with variable flow			•			
Engines	•					
Hydraulic cylinders	•					
Actuators					•	
Test benches						•
Check valve	•					
Directional valves	•					
Flow regulating valves	•					
Proportional valves				•		
Servo-valves					•	
Flat bearings			•			
Ball bearings				•		
ISO 4406 CODE	20/18/15	19/17/14	18/16/13	17/15/12	16/14/11	15/13/10
Recommended filtration $\beta_{x(c)} \geq 1.000$	$\beta_{21(c)} > 1000$	$\beta_{15(c)} > 1000$	$\beta_{10(c)} > 1000$	$\beta_{7(c)} > 1000$	$\beta_{7(c)} > 1000$	$\beta_{5(c)} > 1000$
MP Filtri media code	A25	A16	A10	A06	A06	A03

The common classification of filters is determined by their position in the plant.

## 8 TYPES OF FILTERS

### Suction filters

They are positioned before the pump and are responsible for protecting the pump from dirty contaminants. It also provides additional flow guidance to the pump suction line.

Being subject to negligible working pressures are manufactured with simple and lightweight construction.

They are mainly produced with gross grade surface filtrations, mainly  $60 \div 125 \mu\text{m}$ .

They can be equipped with a magnetic filter for retaining ferrous particles.

They are generally placed under the fluid head to take advantage of the piezometric thrust of the fluid and reduce the risk of cavitation.

There are two types of suction filters:

#### - IMMERSION FILTERS

Simple filter element screwed on the suction pipe

#### - FILTERS WITH CONTAINER

Container filters that are more bulky, but provide easier maintenance of the tank

### Delivery (or Pressure) filters

They are positioned between the pump and most sensitive regulating and controlling components, such as servo valves or proportional valves, and are designed to ensure the class of contamination required by the components used in the circuit.

Being subjected to high working pressures are manufactured with more robust and articulated construction. In particular situations of corrosive environments or aggressive fluids can be made of stainless steel.

They are mainly produced with filtering depths of  $3 \div 25 \mu\text{m}$ .

They can be manufactured with in-line connections, with plate or flange connections or directly integrated into the circuit control blocks / manifolds.

They can also be manufactured in duplex configuration to allow the contaminated section to be maintained even when the plant / system is in operation without interruption of the working cycle.

### Return filters

They are positioned on the return line to the tank and perform the task of filtering the fluid from particles entering the system from the outside or generated by the wear of the components.

They are generally fixed to the reservoir (for this reason also called top tank mounted), positioned semi-immersed or completely immersed.

The positioning of the return filters must guarantee in all operating conditions that the fluid drainage takes place in immersed condition; this is to avoid creating foams in the tank that can cause malfunctions or cavitation in the pumps.

For the sizing of the return filters, account must be taken of the presence of accumulators or cylinders that can make the return flow considerably greater than the pump suction flow rate.

Being subject to contained working pressures are manufactured with simple and lightweight construction.

Normally it is possible to extract the filter element without disconnecting the filter from the rest of the system.

### Combined filters

They are designed to be applied to systems with two or more circuits. They are commonly used in hydrostatic transmission machines where they have a dual filtration function of the return line and suction line of the hydrostatic transmission pump.

The filter is equipped with a valve that keeps the 0.5 bar pressure inside the filter. A portion of the fluid that returns to the tank is filtered by the return filter element, generally produced with absolute filtration, and returns to the transmission booster pump.

Only excess fluid returns to the tank through the valve.

The internal pressure of the filter and the absolute filtration help to avoid the cavitation phenomenon inside the pump.

### Off-line filters

They are generally used in very large systems / plants, placed in a closed circuit independent from the main circuit. They remain in operation regardless of the operation of the main circuit and are crossed by a constant flow rate.

They can also be manufactured in duplex configuration to allow the contaminated section to be maintained even when the unit is in operation without interruption of the work cycle.

### Venting filters

During the operation of the plants, the fluid level present in the reservoir changes continuously.

The result of this continuous fluctuation is an exchange of air with the outside environment.

The venting filter function, positioned on the tank, is to filter the air that enters the tank to compensate for fluid level variations.

## 9 FILTER SIZING PARAMETERS

The choice of the filter system for an hydraulic system is influenced by several factors.

It is necessary to consider the characteristics of the various components present in the plant and their sensitivity to contamination.

It is also necessary to consider all the tasks that the filter will have to do within the plant:

- FLUID PROTECTION FROM CONTAMINATION
- PROTECTION OF OLEODYNAMIC COMPONENTS SENSITIVE TO CONTAMINATION
- PROTECTION OF OLEODYNAMIC PLANTS FROM ENVIRONMENTAL WASTE
- PROTECTION OF OLEODYNAMIC PLANTS FROM CONTAMINATION CAUSED BY COMPONENTS' FAILURES

The advantages of proper positioning and sizing of the filters are

- MORE RELIABILITY OF THE SYSTEM
- LONGER LIFE OF THE FLUID COMPONENTS
- REDUCTION OF STOP TIME
- REDUCTION OF FAILURE CASUALTIES

Each hydraulic filter is described by general features that identify the possibility of use in different applications.

- **MAXIMUM WORKING PRESSURE ( $P_{max}$ )**

The maximum working pressure of the filter must be greater than or equal to the pressure of the circuit section in which it will be installed.

- **PRESSURE DROP ( $\Delta P$ )**

The pressure drop depends on a number of factors, such as the working circuit temperature, the fluid viscosity, the filter element cleaning condition.

- **WORKING TEMPERATURE ( $T$ )**

The working temperature deeply affect the choice of materials. Excessively high or low temperatures may adversely affect the strength of the materials or the characteristics of the seals.

- **FILTRATION EFFICIENCY (%) / FILTRATION RATIO ( $\beta_{x(c)}$ )**

Filtration efficiency is the most important parameter to consider when selecting a filter.

When choosing the filtration performances, the needs of the most sensitive components in the system must be considered.

- **FLUID TYPE**

The type of fluid influences the choice of filters in terms of compatibility and viscosity. It is always mandatory to check the filterability.

- **PLACEMENT IN THE PLANT**

The position of the filter in the system conditions the efficiency of all filter performances.

## 10 APPLICABLE STANDARDS FOR FILTER DEVELOPMENT

In order to obtain unique criteria for development and verification of the filters performance, specific regulations for the filters and filter elements testing have been issued by ISO. These norms describe the target, the methodology, the conditions and the presentation methods for the test results.

### ISO 2941

*Hydraulic fluid power -- Filter elements -- Verification of collapse/burst pressure rating*

This Standard describes the method for testing the collapse / burst resistance of the filter elements.

The test is performed by crossing the contaminated fluid filter element at a predefined flow rate. The progressive clogging of the filter element, determined by contamination, causes an increase in differential pressure.

### ISO 2942

*Hydraulic fluid power -- Filter elements -- Verification of fabrication integrity and determination of the first bubble point*

This Standard describes the method to verify the integrity of the assembled filter elements.

It can be used to verify the quality of the production process or the quality of the materials by verifying the pressure value of the first bubble point.

### ISO 2943

*Hydraulic fluid power -- Filter elements -- Verification of material compatibility with fluids*

This Standard describes the method to verify the compatibility of materials with certain hydraulic fluids.

The test is carried out by keeping the element (the material sample) immersed in the fluid under high or low temperature conditions for a given period of time and verifying the retention of the characteristics.

### ISO 3723

*Hydraulic fluid power -- Filter elements -- Method for end load test*

This Standard describes the method for verifying the axial load resistance of the filter elements.

After performing the procedure described in ISO 2943, the designed axial load is applied to the filter element. To verify the test results, then the test described in ISO 2941 is performed.

### ISO 3968

*Hydraulic fluid power -- Filters -- Evaluation of differential pressure versus flow characteristics*

This Standard describes the method for checking the pressure drop across the filter.

The test is carried out by crossing the filter from a given fluid and by detecting upstream and downstream pressures.

Some of the parameters defined by the Standard are the fluid, the test temperature, the size of the tubes, the position of the pressure detection points.

### ISO 16889

*Hydraulic fluid power -- Filters -- Multi-pass method for evaluating filtration performance of a filter element*

This Standard describes the method to check the filtration characteristics of the filter elements.

The test is performed by constant introduction of contaminant (ISO MTD). The characteristics observed during the test are the filtration efficiency and the dirty holding capacity related to the differential pressure.



## ISO 23181

*Hydraulic fluid power -- Filter elements -- Determination of resistance to flow fatigue using high viscosity fluid*

This Standard describes the method for testing the fatigue resistance of the filter elements. The test is carried out by subjecting the filter to continuous flow variations, thus differential pressure, using a high viscosity fluid.

## ISO 11170

*Hydraulic fluid power -- Sequence of tests for verifying performance characteristics of filter elements*

The Standard describes the method for testing the performance of filter elements. The protocol described by the regulations provides the sequence of all the tests described above in order to verify all the working characteristics (mechanical, hydraulic and filtration).

## ISO 10771-1

*Hydraulic fluid power -- Fatigue pressure testing of metal pressure-containing envelopes -- Test method*

This Standard describes the method to check the resistance of the hydraulic components with pulsing pressure.

It can be applied to all metal components (excluding tubes) subject to cyclic pressure used in the hydraulic field.

## 11 WATER IN HYDRAULIC AND LUBRICATING FLUIDS

### Water Content

In mineral oils and non aqueous resistant fluids water is undesirable. Mineral oil usually has a water content of 50-300 ppm (@40°C) which it can support without adverse consequences.

Once the water content exceeds about 300ppm the oil starts to appear hazy. Above this level there is a danger of free water accumulating in the system in areas of low flow. This can lead to corrosion and accelerated wear.

Similarly, fire resistant fluids have a natural water which may be different to mineral oil.

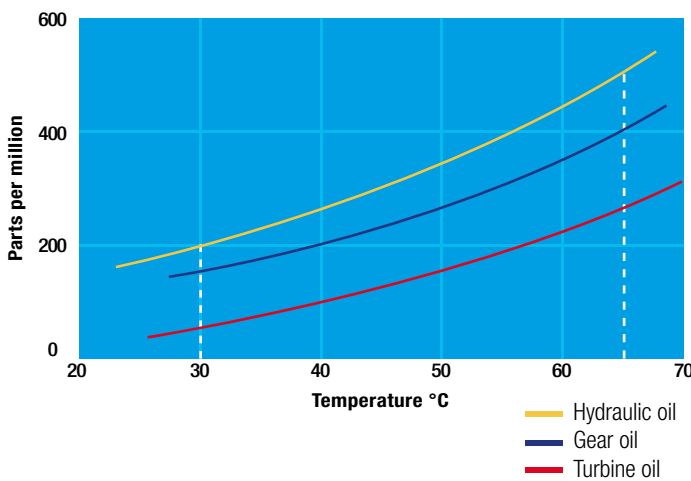

## Saturation Levels

Since the effects of free (also emulsified) water is more harmful than those of dissolved water, water levels should remain well below the saturation point.

However, even water in solution can cause damage and therefore every reasonable effort should be made to keep saturation levels as low as possible. There is no such thing as too little water. As a guideline, we recommend maintaining saturation levels below 50% in all equipment.

### TYPICAL WATER SATURATION LEVEL FOR NEW OILS

Examples:

Hydraulic oil @ 30°C = 200 ppm = 100% saturation

Hydraulic oil @ 65°C = 500 ppm = 100% saturation

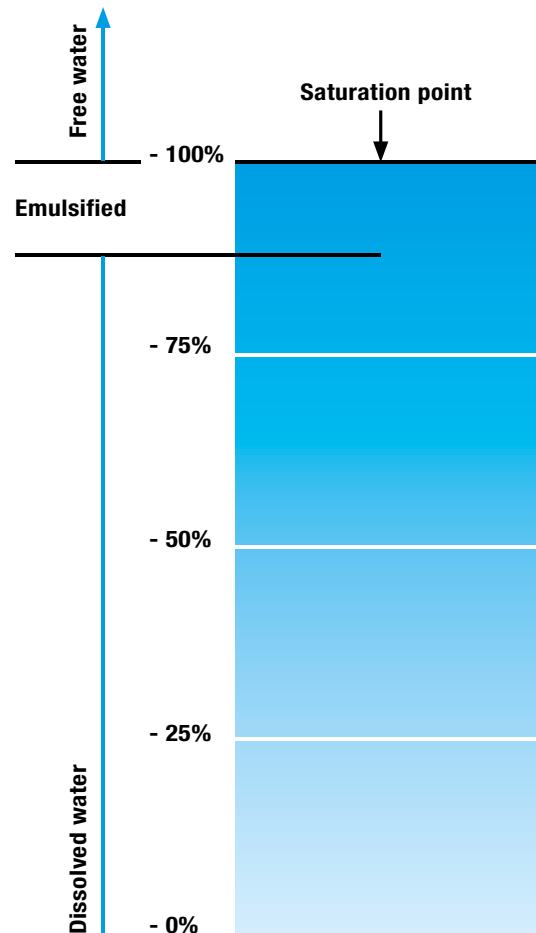

## WATER REMOVAL

Water is present everywhere, during storage, handling and servicing.

MP Filtri filter elements feature an absorbent media which protects hydraulic systems from both particulate and water contamination.

MP Filtri's filter element technology is available with inorganic microfiber media with a filtration rating 25 µm (therefore identified with media designation WA025), providing absolute filtration of solid particles to  $\beta_{x(c)} = 1000$ .

Absorbent media is made by water absorbent fibres which increase in size during the absorption process.

Free water is thus bonded to the filter media and completely removed from the system (it cannot even be squeezed out).

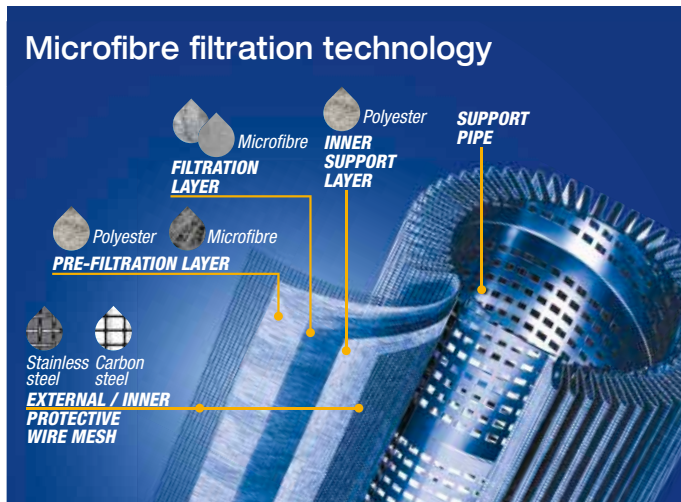
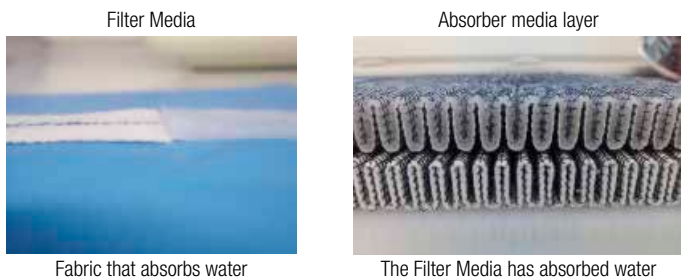

By removing water from your fluid power system, you can prevent such key problems as:

- corrosion (metal etching)
- loss of lubricant power
- accelerated abrasive wear in hydraulic components
- valve-locking
- bearing fatigue
- viscosity variance (reduction in lubricating properties)
- additive precipitation and oil oxidation
- increase in acidity level
- increased electrical conductivity (loss of dielectric strength)
- slow/weak response of control systems

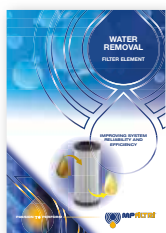

For more details please refer to our dedicate brochure "WATER REMOVAL"



## 12 THE ANTI-STATIC FILTERS



zerospark is a specialist solution designed to solve the problem of electrostatic discharge inside hydraulic filters. Caused by the electrical charge build-up due to the passage of oil through the filters, this can result in damage to filter elements, oils and circuit components. It can even cause fire hazards in environments where flammable materials are present.

### THE TRIBOELECTRIC EFFECT

The body with the most electronegativity strips electrons from the other, generating a build-up of a net negative charge on itself. The other body is charged by the same amount but with the opposite sign, giving rise to very high potential differences. These, if not dissipated, can give rise to electrostatic discharges.

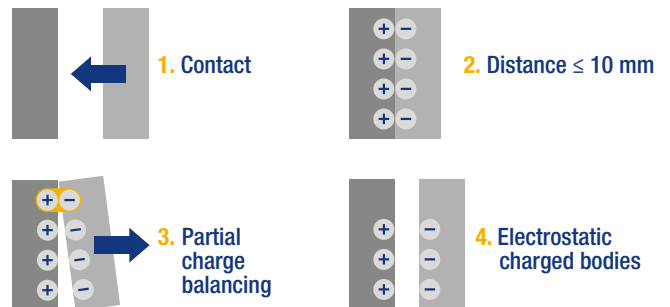

For more details please refer to our dedicate brochure "ZEROSPARK"



# FILTER SIZING

## INDEX

	Page
CALCULATION	22
CORRECTIVE FACTOR	23

# FILTER SIZING Calculation

## THE CORRECT FILTER SIZING HAS TO BE BASED ON THE TOTAL PRESSURE DROP DEPENDING ON THE APPLICATION.

FOR EXAMPLE, THE MAXIMUM TOTAL PRESSURE DROP ALLOWED BY A NEW AND CLEAN RETURN FILTER HAS TO BE IN THE RANGE 0.4 - 0.6 bar / 5.80 - 8.70 psi.

The pressure drop calculation is performed by adding together the value of the housing with the value of the filter element. The pressure drop  $\Delta p_c$  of the housing is proportional to the fluid density ( $\text{kg}/\text{dm}^3$  /  $\text{lb}/\text{ft}^3$ ). The filter element pressure drop  $\Delta p_e$  is proportional to its viscosity ( $\text{mm}^2/\text{s}$  / SUS), the corrective factor Y have to be used in case of an oil viscosity different than  $30 \text{ mm}^2/\text{s}$  (cSt) / 150 SUS.

### Sizing data for single filter element, head at top

$\Delta p_c$  = Filter housing pressure drop [bar / psi]

$\Delta p_e$  = Filter element pressure drop [bar / psi]

Y = Corrective factor Y (see correspondent table), depending on the filter type, on the filter element size, on the filter element length and on the filter media

Q = flow rate (l/min - gpm)

V1 reference oil viscosity =  $30 \text{ mm}^2/\text{s}$  (cSt) / 150 SUS

V2 = operating oil viscosity in  $\text{mm}^2/\text{s}$  (cSt) / SUS

### Filter element pressure drop calculation with an oil viscosity different than $30 \text{ mm}^2/\text{s}$ (cSt) / 150 SUS

International system:

$$\Delta p_e = Y : 1000 \times Q \times (V2:V1)$$

Imperial system:

$$\Delta p_e = Y : 17.2 \times Q \times (V2:V1)$$

$$\Delta p_{\text{Tot.}} = \Delta p_c + \Delta p_e$$

### Verification formula

$$\Delta p_{\text{Tot.}} \leq \Delta p_{\text{max allowed}}$$

### Maximum total pressure drop ( $\Delta p_{\text{max}}$ ) allowed by a new and clean filter

Filter family	$\Delta p_{\text{max}}$	
	[ bar ]	[ psi ]
Suction	0.08 bar	1.15 psi
Return	0.50 bar	7.25 psi
Return - Suction (*)	1.50 bar	22.00 psi
Low & Medium Pressure/Duplex	0.70 bar	10.15 psi
High Pressure Pressure/Duplex	1.50 bar	22.00 psi
Stainless Steel	1.50 bar	22.00 psi
ATEX	1.50 bar	22.00 psi

(\*)The suction flow rate should not exceed 30% of the return flow rate

### Generic filter calculation example

Application data:

Tank top return filter

Pressure Pmax = 10 bar / 145.03 psi

Flow rate Q = 120 l/min / 31.7 gpm

Viscosity V2 =  $46 \text{ mm}^2/\text{s}$  (cSt) / 216 SUS

Oil density =  $0.86 \text{ kg}/\text{dm}^3$  /  $53.68 \text{ lb}/\text{ft}^3$

Required filtration efficiency = 25  $\mu\text{m}$  with absolute filtration

With bypass valve and G 1 1/4" inlet connection

Calculation:

$\Delta p_c = 0.03 \text{ bar} / 0.43 \text{ psi}$  (see graphic below)

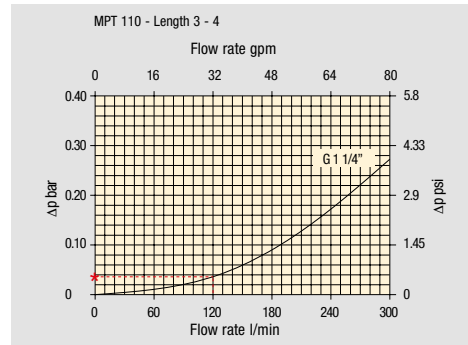

Filter housings  $\Delta p$  pressure drop. The curves are plotted using mineral oil with density of  $0.86 \text{ kg}/\text{dm}^3$  in compliance with ISO 3968.  $\Delta p$  varies proportionally with density.

$$\Delta p_e = (2.00 : 1000) \times 120 \times (46 : 30) = 0.37 \text{ bar}$$

$$\Delta p_e = (2.00 : 17.2) \times 32 \times (216 : 150) = 5.36 \text{ psi}$$

Filter element	Absolute filtration H Series					Nominal filtration N Series		
	A03	A06	A10	A16	A25	P(00)10	P(00)25	M(00)25 M(00)60 M(00)90
<b>Return filters</b>	74.00	50.08	20.00	16.00	9.00	6.43	5.51	4.40
<b>MF 020</b>	2 29.20	24.12	8.00	7.22	5.00	3.33	2.85	2.00
	3 22.00	19.00	6.56	5.33	4.33	1.68	1.44	1.30
<b>MF 030</b>	1 74.00	50.08	20.00	16.00	9.00	6.43	5.51	3.40
<b>MFX 030</b>	1 28.20	24.40	8.67	8.17	6.88	4.62	3.96	1.25
<b>MF 100</b>	2 17.33	12.50	6.86	5.70	4.00	3.05	2.47	1.10
<b>MFX 100</b>	3 10.25	9.00	3.65	3.33	2.50	1.63	1.32	0.96
	4 6.10	5.40	2.30	2.20	2.00	1.19	0.96	0.82

$$\Delta p_{\text{Tot.}} = 0.03 + 0.37 = 0.4 \text{ bar}$$

$$\Delta p_{\text{Tot.}} = 0.43 + 5.36 = 5.79 \text{ psi}$$

The selection is correct because the total pressure drop value is inside the admissible range for top tank return filters.

In case the allowed max total pressure drop is not verified, it is necessary to repeat the calculation changing the filter length/size.

## SUCTION FILTERS

Filter element		Nominal filtration Collapse $\Delta P$ : A = 1 bar					
Type	Length	P10	P25	M25	M60	M90	M250
SF 250	1	78.00	48.00	28.00	24.00	9.33	9.33
SF 503	2	25.88	20.88	10.44	10.00	3.78	3.78
SF 504	3	15.20	14.53	5.14	4.95	2.00	2.00
SF 505	4	3.25	2.55	1.55	1.35	0.71	0.71
SF 510	5	1.96	1.68	0.85	0.72	0.24	0.24
SF 535	2	1.06	0.84	0.42	0.33	0.17	0.17
SF 540	4	1.06	0.84	0.42	0.33	0.17	0.17
FEX 060	-	4.58	3.22	1.02	0.89	0.63	0.63
FEX 080	-	1.97	1.38	0.62	0.45	0.29	0.29
FEX 110	-	1.33	1.12	0.22	0.18	0.14	0.14
FEX 160	-	0.90	0,76	0.15	0.10	0.09	0.09

## RETURN FILTERS

Filter element		Absolute filtration H Series					Nominal filtration N Series		
Type	Length	A03	A06	A10	A16	A25	P10	P25	M25 - M60 - M90
MF 020	1	74.00	50.08	20.00	16.00	9.00	6.43	5.51	4.40
	2	29.20	24.12	8.00	7.22	5.00	3.33	2.85	2.00
	3	22.00	19.00	6.56	5.33	4.33	1.68	1.44	1.30
MF 030 MFX 030	1	74.00	50.08	20.00	16.00	9.00	6.43	5.51	3.40
MF 100 MFX 100	1	28.20	24.40	8.67	8.17	6.88	4.62	3.96	1.25
	2	17.33	12.50	6.86	5.70	4.00	3.05	2.47	1.10
	3	10.25	9.00	3.65	3.33	2.50	1.63	1.32	0.96
	4	6.10	5.40	2.30	2.20	2.00	1.19	0.96	0.82
MF 180 MFX 180	1	3.67	3.05	1.64	1.56	1.24	1.18	1.06	0.26
	2	1.69	1.37	0.68	0.54	0.51	0.43	0.39	0.12
MF 190 MFX 190	2	1.69	1.37	0.60	0.49	0.44	0.35	0.31	0.11
MF 400 MFX 400	1	3.20	2.75	1.39	1.33	1.06	0.96	0.87	0.22
	2	2.00	1.87	0.88	0.85	0.55	0.49	0.45	0.13
	3	1.90	1.60	0.63	0.51	0.49	0.39	0.35	0.11
MF 750 MFX 750	1	1.08	0.84	0.49	0.36	0.26	0.21	0.19	0.06
MLX 250	2	3.00	3.04	1.46	1.25	1.17	-	-	M25 0.20
MLX 660	2	1.29	1.26	0.52	0.44	0.38	-	-	M25 0.10
CU 025		78.00	48.00	28.00	24.00	9.33	9.33	8.51	1.25
CU 040		25.88	20.88	10.44	10.00	3.78	3.78	3.30	1.25
CU 100		15.20	14.53	5.14	4.95	2.00	2.00	0.17	1.10
CU 250		3.25	2.55	1.55	1.35	0.71	0.71	0.59	0.25
CU 630		1.96	1.68	0.85	0.72	0.24	0.42	0.36	0.09
CU 850		1.06	0.84	0.42	0.33	0.17	0.17	0.13	0.04

TO BE CONTINUED >>

Corrective factor Y to be used for the filter element pressure drop calculation. The values depend to the filter size and length and to the filter media.  
Reference oil viscosity 30 mm<sup>2</sup>/s

# FILTER SIZING Corrective factor

## RETURN FILTERS

Filter element		Absolute filtration H Series					Nominal filtration N Series		
Type	Length	A03	A06	A10	A16	A25	P10	P25	M25 - M60 - M90
<b>MR 250</b>	2	3.61	4.08	1.81	1.71	1.35	-	-	M25 0.55
	4	2.10	1.70	1.14	0.77	0.53	-	-	0.60
<b>MR 100</b>	1	19.00	17.00	6.90	6.30	4.60	2.94	2.52	1.60
	2	11.70	10.80	4.40	4.30	3.00	2.94	2.52	1.37
	3	7.80	6.87	3.70	3.10	2.70	2.14	1.84	1.34
	4	5.50	4.97	2.60	2.40	2.18	1.72	1.47	1.34
	5	4.20	3.84	2.36	2.15	1.90	1.60	1.37	1.34
<b>MR 250</b>	1	5.35	4.85	2.32	1.92	1.50	1.38	1.20	0.15
	2	4.00	3.28	1.44	1.10	1.07	0.96	0.83	0.13
	3	2.60	2.20	1.08	1.00	0.86	0.77	0.64	0.12
	4	1.84	1.56	0.68	0.56	0.44	0.37	0.23	0.11
<b>MR 630</b>	1	3.10	2.48	1.32	1.14	0.92	0.83	0.73	0.09
	2	2.06	1.92	0.82	0.76	0.38	0.33	0.27	0.08
	3	1.48	1.30	0.60	0.56	0.26	0.22	0.17	0.08
	4	1.30	1.20	0.48	0.40	0.25	0.21	0.16	0.08
	5	0.74	0.65	0.30	0.28	0.13	0.10	0.08	0.04
<b>MR 850</b>	1	0.60	0.43	0.34	0.25	0.13	0.12	0.09	0.03
	2	0.37	0.26	0.23	0.21	0.11	0.08	0.07	0.03
	3	0.27	0.18	0.17	0.17	0.05	0.04	0.04	0.02
	4	0.23	0.16	0.13	0.12	0.04	0.03	0.03	0.02

## RETURN / SUCTION FILTERS

Filter element		Absolute filtration		
Type	Length	A10	A16	A25
<b>RSX 116</b>	1	5.12	4.33	3.85
	2	2.22	1.87	1.22
<b>RSX 165 RSX 166</b>	1	2.06	1.75	1.46
	2	1.24	1.05	0.96
	3	0.94	0.86	0.61

Filter element		Absolute filtration N Series							
Type	Length	A03	A06	A10	A16	A25	P10	P25	M25 - M60 - M90
<b>CU 110</b>	1	16.25	15.16	8.75	8.14	5.87	2.86	2.65	0.14
	2	12.62	10.44	6.11	6.02	4.16	1.60	1.49	0.12
	3	8.57	7.95	5.07	4.07	2.40	1.24	1.15	0.11
	4	5.76	4.05	4.05	2.36	1.14	0.91	0.85	0.05

Corrective factor Y to be used for the filter element pressure drop calculation. The values depend to the filter size and length and to the filter media.  
Reference oil viscosity 30 mm<sup>2</sup>/s

## LOW & MEDIUM PRESSURE FILTERS

Filter element		Absolute filtration N - W Series					Nominal filtration N Series		
Type	Length	A03	A06	A10	A16	A25	P10	P25	M25
<b>CU 110</b>	1	16.25	15.16	8.75	8.14	5.87	2.86	2.65	0.14
	2	12.62	10.44	6.11	6.02	4.15	1.60	1.49	0.12
	3	8.57	7.95	5.07	4.07	2.40	1.24	1.15	0.11
	4	5.76	4.05	2.80	2.36	1.14	0.91	0.85	0.05
<b>CU 210</b>	1	5.30	4.80	2.00	1.66	1.32	0.56	0.43	0.12
	2	3.44	2.95	1.24	1.09	0.70	0.42	0.35	0.09
	3	2.40	1.70	0.94	0.84	0.54	0.33	0.23	0.05
<b>DN</b>	016	7.95	7.20	3.00	2.49	1.98	0.84	0.65	0.18
	025	5.00	4.53	1.89	1.57	1.25	0.53	0.41	0.11
	040	3.13	2.66	1.12	0.98	0.63	0.38	0.32	0.08
<b>CU 400</b>	2	3.14	2.55	1.46	1.22	0.78	0.75	0.64	0.19
	3	2.15	1.70	0.94	0.78	0.50	0.40	0.34	0.10
	4	1.60	1.28	0.71	0.61	0.40	0.34	0.27	0.08
	5	1.00	0.83	0.47	0.34	0.20	0.24	0.19	0.06
	6	0.82	0.58	0.30	0.27	0.17	0.22	0.18	0.105
<b>CU 900</b>	1	0.86	0.63	0.32	0.30	0.21	-	-	0.05
<b>CU 950</b>	2	1.03	0.80	0.59	0.40	0.26	-	-	0.05
	3	0.44	0.40	0.27	0.18	0.15	-	-	0.02
<b>MR 630</b>	7	0.88	0.78	0.36	0.34	0.16	0.12	0.96	0.47

## HIGH PRESSURE FILTERS

Filter element		Absolute filtration N - R Series					Nominal filtration N Series
Type	Length	A03	A06	A10	A16	A25	M25
<b>HP 010 HP 011</b>	1	332.71	250.07	184.32	152.36	128.36	-
	2	220.28	165.56	74.08	59.13	37.05	-
	3	123.24	92.68	41.48	33.08	20.72	-
	4	77.76	58.52	28.37	22.67	16.17	-
<b>HP 039</b>	2	70.66	53.20	25.77	20.57	14.67	4.90
	3	36.57	32.28	18.00	13.38	8.00	2.90
	4	26.57	23.27	12.46	8.80	5.58	2.20
<b>HP 050 HPX 050</b>	1	31.75	30.30	13.16	12.3	7.29	1.60
	2	24.25	21.26	11.70	9.09	4.90	1.40
	3	17.37	16.25	8.90	7.18	3.63	1.25
	4	12.12	10.75	6.10	5.75	3.08	1.07
	5	7.00	6.56	3.60	3.10	2.25	0.80
<b>HP 065</b>	1	58.50	43.46	23.16	19.66	10.71	1.28
	2	42.60	25.64	16.22	13.88	7.32	1.11
	3	20.50	15.88	8.18	6.81	3.91	0.58
<b>HP 135</b>	1	20.33	18.80	9.71	8.66	4.78	2.78
	2	11.14	10.16	6.60	6.38	2.22	1.11
	3	6.48	6.33	3.38	3.16	2.14	1.01
<b>HP 150</b>	1	17.53	15.91	7.48	6.96	5.94	1.07
	2	8.60	8.37	3.54	3.38	3.15	0.58
	3	6.53	5.90	2.93	2.79	2.12	0.49

TO BE CONTINUED >>

**Corrective factor Y to be used for the filter element pressure drop calculation. The values depend to the filter size and length and to the filter media.**  
Reference oil viscosity 30 mm<sup>2</sup>/s

# FILTER SIZING Corrective factor

## HIGH PRESSURE FILTERS

Filter element		Absolute filtration N - R Series					Nominal filtration N Series
Type	Length	A03	A06	A10	A16	A25	M25
HP 320	1	10.88	9.73	5.02	3.73	2.54	1.04
	2	4.40	3.83	1.75	1.48	0.88	0.71
	3	2.75	2.11	1.05	0.87	0.77	0.61
	4	2.12	1.77	0.98	0.78	0.55	0.47
HP 500	1	4.44	3.67	2.30	2.10	1.65	0.15
	2	3.37	2.77	1.78	1.68	1.24	0.10
	3	2.22	1.98	1.11	1.09	0.75	0.08
	4	1.81	1.33	0.93	0.86	0.68	0.05
	5	1.33	1.15	0.77	0.68	0.48	0.04
HP 325	1	3.65	2.95	2.80	1.80	0.90	0.38
	2	2.03	1.73	1.61	1.35	0.85	0.36
	3	1.84	1.42	1.32	1.22	0.80	0.35

Filter element		Absolute filtration S - H - U Series				
Type	Length	A03	A06	A10	A16	A25
HP 010	1	424.58	319.74	235.17	194.44	163.78
	2	281.06	211.25	94.35	75.45	47.26
HP 011	3	130.14	97.50	43.63	34.82	21.81
	4	109.39	82.25	36.79	29.37	18.40
HP 039	2	73.00	57.00	28.00	24.00	17.20
	3	40.90	36.33	21.88	18.80	11.20
	4	31.50	28.22	17.22	9.30	6.70
HP 050 HPX 050	1	47.33	34.25	21.50	20.50	14.71
	2	29.10	25.95	10.04	10.90	5.88
	3	20.85	19.50	10.68	8.61	4.36
	4	14.55	12.90	7.32	6.90	3.69
	5	9.86	9.34	6.40	4.80	2.50
HP 135	1	29.16	25.33	13.00	12.47	5.92
	2	14.28	11.04	7.86	7.90	4.44
	3	8.96	7.46	4.89	4.16	3.07
HP 320	1	13.00	12.19	6.80	6.40	3.32
	2	6.45	5.31	3.01	2.89	1.73
	3	4.13	3.14	1.90	1.78	1.17
	4	3.17	2.71	1.80	1.70	1.10
HP 500	1	9.70	8.81	4.55	4.47	2.80
	2	5.46	4.63	2.88	2.68	2.20
	3	3.90	3.74	2.22	2.07	1.53
	4	3.10	2.84	1.56	1.53	1.02
	5	1.93	1.83	1.14	1.08	0.69

Corrective factor Y to be used for the filter element pressure drop calculation. The values depend to the filter size and length and to the filter media.  
Reference oil viscosity 30 mm<sup>2</sup>/s



## STAINLESS STEEL HIGH PRESSURE FILTERS

Filter element		Absolute filtration N - R Series					Nominal filtration N Series
Type	Length	A03	A06	A10	A16	A25	M25
<b>HP 010 HP 011</b>	1	332.71	250.07	184.32	152.36	128.36	-
	2	220.28	165.56	74.08	59.13	37.05	-
	3	123.24	92.68	41.48	33.08	20.72	-
	4	77.76	58.52	28.37	22.67	16.17	-
<b>HP 039</b>	2	70.66	53.20	25.77	20.57	14.67	4.90
	3	36.57	32.28	18.00	13.38	8.00	2.90
	4	26.57	23.27	12.46	8.80	5.58	2.20
<b>HP 050</b>	1	31.75	30.30	13.16	12.3	7.29	1.60
	2	24.25	21.26	11.70	9.09	4.90	1.40
	3	17.37	16.25	8.90	7.18	3.63	1.25
	4	12.12	10.75	6.10	5.75	3.08	1.07
	5	7.00	6.56	3.60	3.10	2.25	0.80
<b>HP 135</b>	1	20.33	18.80	9.71	8.66	4.78	2.78
	2	11.14	10.16	6.60	6.38	2.22	1.11
	3	6.48	6.33	3.38	3.16	2.14	1.01

Filter element		Absolute filtration S - H - U Series				
Type	Length	A03	A06	A10	A16	A25
<b>HP 010 HP 011</b>	1	424.58	319.74	235.17	194.44	163.78
	2	281.06	211.25	94.35	75.45	47.26
	3	130.14	97.50	43.63	34.82	21.81
	4	109.39	82.25	36.79	29.37	18.40
<b>HP 039</b>	2	73.00	57.00	28.00	24.00	17.20
	3	40.90	36.33	21.88	18.80	11.20
	4	31.50	28.22	17.22	9.30	6.70
<b>HP 050</b>	1	47.33	34.25	21.50	20.50	14.71
	2	29.10	25.95	10.04	10.90	5.88
	3	20.85	19.50	10.68	8.61	4.36
	4	14.55	12.90	7.32	6.90	3.69
	5	9.86	9.34	6.40	4.80	2.50
<b>HP 135</b>	1	29.16	25.33	13.00	12.47	5.92
	2	14.28	11.04	7.86	7.90	4.44
	3	8.96	7.46	4.89	4.16	3.07

**Corrective factor Y to be used for the filter element pressure drop calculation. The values depend to the filter size and length and to the filter media.**  
Reference oil viscosity 30 mm<sup>2</sup>/s

# FILTER SIZING Corrective factor

## FILTERS FOR POTENTIALLY EXPLOSIVE ATMOSPHERE

Filter element		Absolute filtration N - R Series					Nominal filtration N Series
Type	Length	A03	A06	A10	A16	A25	M25
<b>HP 010</b> <b>HP 011</b>	1	332.71	250.07	184.32	152.36	128.36	-
	2	220.28	165.56	74.08	59.13	37.05	-
	3	123.24	92.68	41.48	33.08	20.72	-
	4	77.76	58.52	28.37	22.67	16.17	-
<b>HP 039</b>	2	70.66	53.20	25.77	20.57	14.67	4.90
	3	36.57	32.28	18.00	13.38	8.00	2.90
	4	26.57	23.27	12.46	8.80	5.58	2.20
<b>HPX 050</b>	1	31.75	30.30	13.16	12.3	7.29	1.60
	2	24.25	21.26	11.70	9.09	4.90	1.40
	3	17.37	16.25	8.90	7.18	3.63	1.25
	4	12.12	10.75	6.10	5.75	3.08	1.07
	5	7.00	6.56	3.60	3.10	2.25	0.80
<b>HP 135</b>	1	20.33	18.80	9.71	8.66	4.78	2.78
	2	11.14	10.16	6.60	6.38	2.22	1.11
	3	6.48	6.33	3.38	3.16	2.14	1.01

Filter element		Absolute filtration S - H - U Series				
Type	Length	A03	A06	A10	A16	A25
<b>HP 010</b> <b>HP 011</b>	1	424.58	319.74	235.17	194.44	163.78
	2	281.06	211.25	94.35	75.45	47.26
	3	130.14	97.50	43.63	34.82	21.81
	4	109.39	82.25	36.79	29.37	18.40
<b>HP 039</b>	2	73.00	57.00	28.00	24.00	17.20
	3	40.90	36.33	21.88	18.80	11.20
	4	31.50	28.22	17.22	9.30	6.70
<b>HPX 050</b>	1	47.33	34.25	21.50	20.50	14.71
	2	29.10	25.95	10.04	10.90	5.88
	3	20.85	19.50	10.68	8.61	4.36
	4	14.55	12.90	7.32	6.90	3.69
	5	9.86	9.34	6.40	4.80	2.50
<b>HP 135</b>	1	29.16	25.33	13.00	12.47	5.92
	2	14.28	11.04	7.86	7.90	4.44
	3	8.96	7.46	4.89	4.16	3.07

Corrective factor Y to be used for the filter element pressure drop calculation. The values depend to the filter size and length and to the filter media.

# Filters sizing software

The web-based software program will allow you to select the most suitable MP Filtri's Filters, in accordance with your process design requirements.

The program will automatically check your input design process prior to propose you the acceptable solutions and create an output in PDF report style format.

The MP Filtri Selection Tool software program is easy to use with a flexible fast design method and provides improved layout formats with full descriptions.

The web-based tool is available at MP Filtri website at following link: <https://www.mpfiltri.com/tools/>

The related, complete user guide is available as Manual and downloadable from the "Download" section of MP Filtri website, as well as scanning the following QR code



MP Filtri knows how to manage it thanks to our



## ATEX CERTIFIED PRODUCTS

Standard ATEX Directive 2014/34/EU and UK Regulation S.I. 2016 No. 1107 (as amended)

### FIRE TRIANGLE

According to the legislation, each appliance used in explosive atmospheres must ensure adequate ATEX protection, that is, it must present the precautions necessary to ensure it is removed at least one of the components of the triangle of fire.

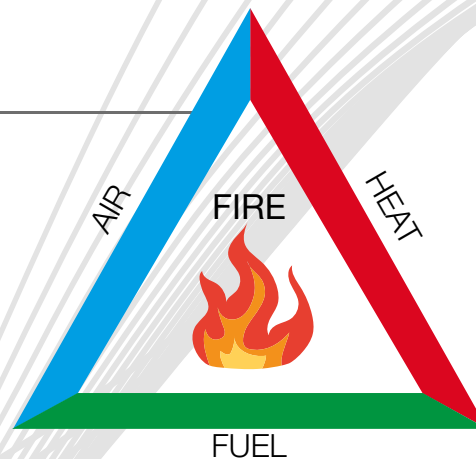

**zerospark<sup>®</sup>**  
**THE ANTI-STATIC FILTERS**

zerospark<sup>®</sup> filter element  
is the default concept for all MP Filtri ATEX filters

### FILTER SIZING

For the proper corrective factor Y see chapter at page 28

# Filters for potentially explosive atmosphere



FMMX050	page 663
FZP	671
FZH	681
FZX	691
INDICATORS	719



### THE X CONCEPT FOR OUR FILTERS

Protect the performance of your system with MYclean.

Quality and efficiency are fundamental for MP Filtri: this exclusive new filter element possesses polygon shape geometry and specific seal that ensures only original spare parts can be used - ensuring correct operation and higher system reliability.

+



### THE Z CONCEPT FOR OUR FILTERS

Zerospark® is a specialist solution designed to solve the problem of electrostatic discharge inside hydraulic filters. Caused by the electrical charge build-up due to the passage of oil through the filters, this can result in damage to filter elements, oils and circuit components. It can even cause fire hazards in environments where flammable materials are present.



FMMX 050 ATEX series 

with  + 

HPX 050 Filter Element

- ◆ **Protects the machine from improper use of non-original products.**
- ◆ **Safety of constant quality protection & reliability**

With exclusive filter element you are sure that only MP Filtri filter elements can be used, ensuring the best cleaning level of the oil due to the use of originals filter elements.

The products identified as FMMX 050 are protected by:

- ◆ Italian Patent n° 102014902261205
- ◆ Canadian Patent n° 2,937,258
- ◆ European Patent n° 3 124 092 B1
- ◆ US Patent n° 20170030384 A1

# FMMX 050 series

Maximum working pressure up to 42 MPa (420 bar) - Flow rate up to 154 l/min



## INSTALLATION, SERVICE AND MAINTENANCE MANUAL AND SAFETY INSTRUCTIONS



Please scan the QR codes  
to get updated electronic version  
of the related document.





# FMMX 050 GENERAL INFORMATION

## Description

## Technical data

### Filters for potentially explosive atmosphere

#### In-line

**Maximum working pressure up to 42 MPa (420 bar)**  
**Flow rate up to 154 l/min**

FMMX is a range of versatile high pressure filter for protection of sensitive components in high pressure hydraulic systems in the mobile machines. They are directly connected to the lines of the system through the hydraulic fittings.

#### Available features:



- Female threaded connections up to 1 1/4", for a maximum flow rate of 250 l/min
- Fine filtration rating, to get a good cleanliness level into the system
- Bypass valve, to relieve excessive pressure drop across the filter media
- Low collapse filter element with external support "N", for filter element protection against the back pressure caused by the check valve in filters provided with the bypass valve
- Visual, electrical and electronic differential clogging indicators
- MYclean interface connection for the filter element, to protect the product against non-original spare parts

#### Common applications:

- Agricultural machines
- Mobile machines



#### Filter with:

NBR seal in configuration **zerospark+**

   **II 3G Ex h IIC T6 Gc X**  
**II 3D Ex h IIIC T85°C Dc X**

FPM seal in configuration

**zerospark+**

   **II 3G Ex h IIC T6... T4 Gc X**  
**II 3D Ex h IIIC T85°C...T115°C Dc X**

#### Filter housing materials

- Head: Painted cast iron, black RAL 9005
- Housing: Phosphatized steel
- Bypass valve: Steel

#### Pressure

- Test pressure: 63 MPa (630 bar)
- Burst pressure: 126 MPa (1260 bar)
- Pulse pressure fatigue test: 1 000 000 cycles with pressure from 0 to 42 MPa (420 bar)

#### Bypass valve

- Opening pressure 600 kPa (6 bar) ±10%
- Other opening pressures on request.

#### Δp element type

- Microfiber filter elements - series N: 20 bar
- Wire mesh filter elements - series N: 20 bar
- Fluid flow through the filter element from OUT to IN

#### Seals

- Standard NBR series A
- Optional FPM series V

#### Connections

In-line Inlet/Outlet

#### Note

FMMX filters are provided for vertical mounting

#### Temperature

Seals	Ambient Temperature	Max fluid Temperature	Temperature Class	Max surface temperature
NBR	-15 °C ÷ +80 °C	+80 °C	T6	T85 °C
FPM	-15 °C ÷ +80 °C	+80 °C	T6	T85 °C
	-15 °C ÷ +95 °C	+95 °C	T5	T100 °C
	-15 °C ÷ +110 °C	+110 °C	T4	T115 °C

## Weights [kg] and volumes [dm<sup>3</sup>]

Filter series	Weights [kg]					Volumes [dm <sup>3</sup> ]						
	Length	1	2	3	4	5	Length	1	2	3	4	5
<b>FMMX 050</b>		3.11	3.48	3.90	4.36	5.54		0.34	0.48	0.63	0.81	1.23



Filter series	Length	Filter element design - N Series					
		A03	A06	A10	A16	A25	M25
<b>FMMX 050</b>	<b>1</b>	42	43	79	82	106	147
	<b>2</b>	52	57	85	96	121	149
	<b>3</b>	66	69	97	106	130	150
	<b>4</b>	83	89	113	115	134	152
	<b>5</b>	107	110	130	134	141	154

### Maximum flow rate for a complete pressure filter with a pressure drop $\Delta p = 1.5$ bar.

The reference fluid has a kinematic viscosity of 30 mm<sup>2</sup>/s (cSt) and a density of 0.86 kg/dm<sup>3</sup>.

For different pressure drop or fluid viscosity we recommend to use our selection software available on [www.mpfiltri.com](http://www.mpfiltri.com).

You can also calculate the right size using the formulas present on the FILTER SIZING paragraph at the beginning of the full catalogue or at the beginning of the filter family brochure. Please, contact our Sales Department for further additional information.

### Hydraulic symbols

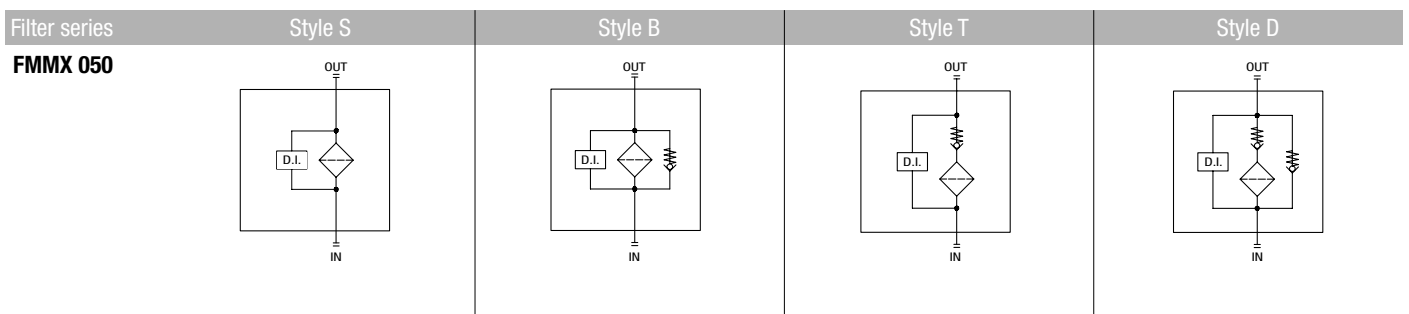

Pressure drop  
Filter housings  
 $\Delta p$  pressure drop

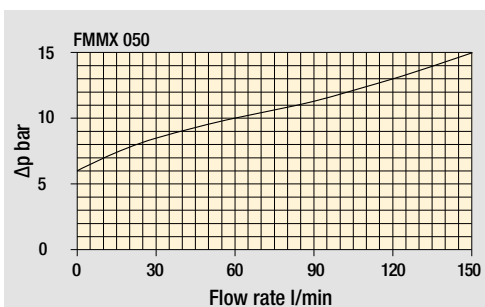
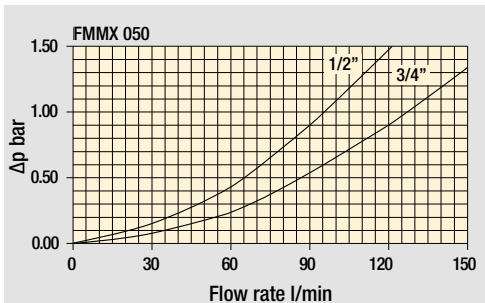

Bypass valve  
pressure drop

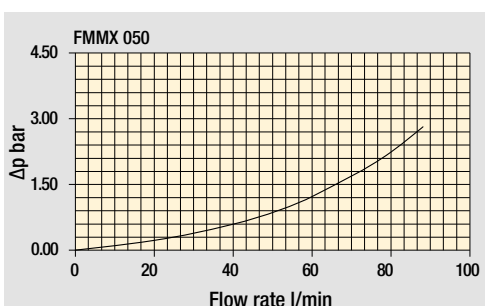

Filter housing  
with check valve

Valves

The curves are plotted using mineral oil with density of 0.86 kg/dm<sup>3</sup> in compliance with ISO 3968.  $\Delta p$  varies proportionally with density.

# FMMX 050

## Designation & Ordering code

### COMPLETE FILTER

Configuration example: **FMMX050** | **3** | **B** | **A** | **G** | **A10** | **N** | **Z01** | **EX**

**Series and size**  
**FMMX050** Filter featuring **MYCLEAN** Filter Element

**Length**  
**1** | **2** | **3** | **4** | **5**

**Valves**  
**B** With bypass 6 bar  
**D** With check valve, with bypass 6 bar

**Seals**  
**A** NBR  
**V** FPM

**Connections**

<b>A</b> M18x1.5 - ISO 6149	<b>E</b> 1/2" NPT
<b>B</b> M22x1.5 - ISO 6149	<b>F</b> 3/4" NPT
<b>C</b> G 1/2"	<b>G</b> SAE 8 - 3/4" - 16 UNF
<b>D</b> G 3/4"	<b>H</b> SAE 12 - 1 1/16" - 12 UN

**Filtration rating (filter media)**

<b>A03</b> Inorganic microfiber	3 µm
<b>A06</b> Inorganic microfiber	6 µm
<b>A10</b> Inorganic microfiber	10 µm
<b>A16</b> Inorganic microfiber	16 µm
<b>A25</b> Inorganic microfiber	25 µm
<b>M25</b> Wire mesh	25 µm

**Element Δp**  
**N** 20 bar

**Executions**

<b>zero<span style="color: orange;">spark</span></b>
<b>Z01</b> Upper connection for clogging indicator
<b>Z02</b> Without connection for clogging indicator
<b>Z03</b> Frontal connection for clogging indicator
<b>Zxx</b> Customized

**Certifications**  
**EX** ATEX certifications

### FILTER ELEMENT

Configuration example: **HPX050** | **3** | **A10** | **A** | **N** | **Z01**

**Element series and size**  
**HPX050** Filter Element with **MYCLEAN** feature

**Element length**  
**1** | **2** | **3** | **4** | **5**

**Filtration rating (filter media)**

<b>A03</b> Inorganic microfiber	3 µm
<b>A06</b> Inorganic microfiber	6 µm
<b>A10</b> Inorganic microfiber	10 µm
<b>A16</b> Inorganic microfiber	16 µm
<b>A25</b> Inorganic microfiber	25 µm
<b>M25</b> Wire mesh	25 µm

**Seals**  
**A** NBR  
**V** FPM

**Element Δp**  
**N** 20 bar

**Execution**

<b>zero<span style="color: orange;">spark</span></b>
<b>Z01</b> MP Filtri standard
<b>Zxx</b> Customized

### CLOGGING INDICATORS

See page 719

**DEH** Electrical differential pressure indicator 420 bar  
**DVA** Visual differential pressure indicator

**DVM** Visual differential pressure indicator

### PLUGS

See page 737

**T2** Plug

# FMMX 050

## Dimensions

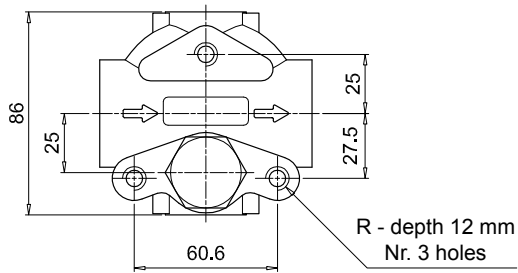
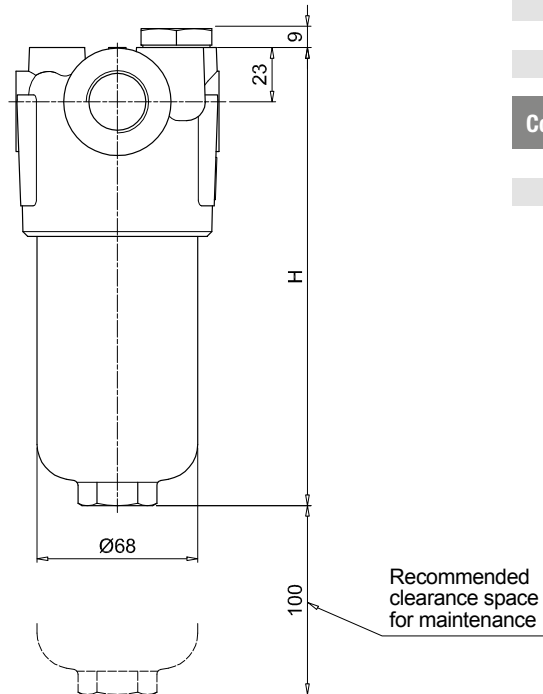
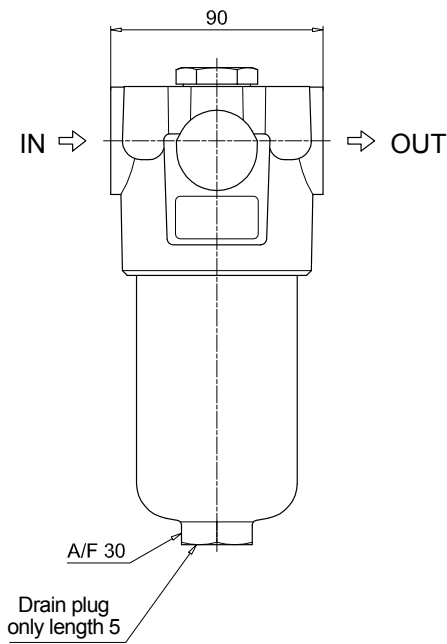

FMMX050	
Filter length	H [mm]
1	158
2	195
3	237
4	285
5	407
Connections	R
A-B-C-D	M10
E-F-G-H	3/8" UNC

Execution P01

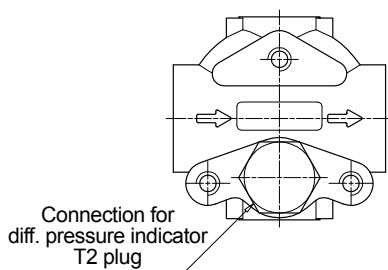

Execution P02

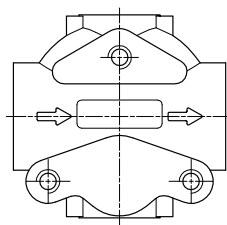

Execution P03

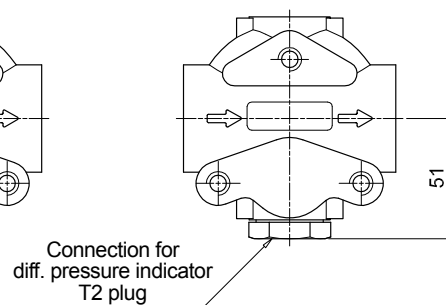

# FMMX 050 SPARE PARTS

Order number for spare parts

## FMMX 050

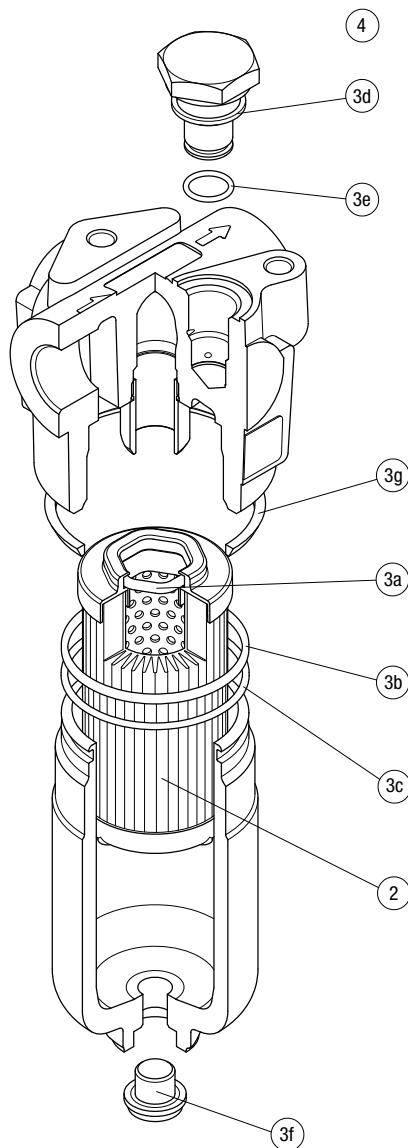

Item:	Q.ty: 1 pc.	Q.ty: 1 pc.		Q.ty: 1 pc.	
Filter series	Filter element	Seal Kit code number		Indicator connection plug	
FMMX 050	See order table	NBR	FPM	NBR	FPM
	2	3 (3a ÷ 3g)		4	
		02050864	02050865	T2H	T2V





# FZP series

Maximum working pressure up to 42 Mpa (420 bar) - Flow rate up to 160 l/min



## INSTALLATION, SERVICE AND MAINTENANCE MANUAL AND SAFETY INSTRUCTIONS



Please scan the QR codes  
to get updated electronic version  
of the related document.





## Description

## Technical data

### Filters for potentially explosive atmosphere

#### In-line

**Maximum working pressure up to 42 Mpa (420 bar)**  
**Flow rate up to 160 l/min**

FZP is a range of stainless steel high pressure filter for protection of sensitive components in high pressure hydraulic systems placed in difficult environmental conditions.

They are directly connected to the lines of the system through the hydraulic fittings.

#### Available features:

- 1 1/4" female threaded connections, for a maximum flow rate of 160 l/min
- Fine filtration rating, to get a good cleanliness level into the system
- Bypass valve, to relieve excessive pressure drop across the filter media
- Low collapse filter element with external support "R", for filter element protection against the back pressure caused by the check valve or the reverse flow in filters provided with the bypass valve
- High collapse filter element with external support "S", for filter element protection against the back pressure caused by the check valve or the reverse flow in filters not provided with the bypass valve
- High collapse filter element "U", for use with aggressive fluids
- Visual, electrical and electronic differential clogging indicators

#### Common applications:

- Off-shore equipment
- Water filtration systems
- Systems with strong or corrosive environmental conditions
- Systems with corrosive fluids

#### Filter housing materials

- Head: AISI 316L
- Housing: AISI 316L
- Bypass valve: AISI 316L

#### Seals

- Standard NBR series A
- Optional FPM series V
- Optional MFQ series F

#### Bypass valve

Opening pressure 6 bar  $\pm$ 10%

#### Note

FZP filters are provided for vertical mounting

#### $\Delta p$ element type

Fluid flow through the filter element from OUT to IN

Microfibre filter elements - series R: 20 bar.

Element series "R":

- End cap: Polyamide
- Core tube: Tinned steel
- External/Internal support: Wire mesh Epox painted
- Media/Support/Pre-filter: Microfibre/Syntetic

Microfibre filter elements - series S: 210 bar.

Element series "S":

- End cap: Tinned steel
- Core tube: Tinned steel
- External support: Wire mesh Epox painted
- Internal support: Wire mesh stainless steel
- Media/Support/Pre-filter: Microfibre/Syntetic

Stainless Steel Microfibre filter elements series U: 210 bar.

Element series "U":

- End cap: Stainless steel
- Core tube: Stainless steel
- External support: Stainless steel
- Internal support: Stainless steel
- Media/Support/Pre-filter: Microfibre/Syntetic

#### Temperature

Seals	Ambient Temperature	Max fluid Temperature	Temperature Class	Max surface temperature
NBR	-15 °C ÷ +80 °C	+80 °C	T6	T85 °C
FPM / MFQ	-15 °C ÷ +80 °C	+80 °C	T6	T85 °C
	-15 °C ÷ +95 °C	+95 °C	T5	T100 °C
	-15 °C ÷ +110 °C	+110 °C	T4	T115 °C

#### Filter with:

NBR seal in configuration **zerospark<sup>+</sup>**



II 3G Ex h IIC T6 Gc X  
 II 3D Ex h IIIC T85°C Dc X

FPM / MFQ seal in configuration **zerospark<sup>+</sup>**



II 3G Ex h IIC T6... T4 Gc X  
 II 3D Ex h IIIC T85°C...T115°C Dc X

## Weights [kg] and volumes [dm<sup>3</sup>]

Filter series	Weights [kg]				Volumes [dm <sup>3</sup> ]					
	Length	1	2	3	4	Length	1	2	3	4
<b>FZP 039</b>	-	4.5	5.1	5.6	-	0.19	0.26	0.34	-	-
<b>FZP 136</b>	8.3	10.2	11.5	-	0.45	0.78	1.00	-	-	-

Filter series	Length	Filter element design - R Series					Filter element design - S-U Series				
		A03	A06	A10	A16	A25	A03	A06	A10	A16	A25
<b>FZP 039</b>	<b>2</b>	19	25	43	50	59	19	23	41	45	55
	<b>3</b>	34	37	53	62	74	31	34	48	52	66
	<b>4</b>	42	46	63	72	81	38	41	55	71	78
<b>FZP 136</b>	<b>1</b>	63	67	102	108	136	47	53	87	89	127
	<b>2</b>	95	100	122	123	159	81	95	113	115	138
	<b>3</b>	122	124	148	150	160	106	116	135	141	151

### Maximum flow rate for a complete stainless steel high pressure filter with a pressure drop $\Delta p = 1.5$ bar.

The reference fluid has a kinematic viscosity of 30 mm<sup>2</sup>/s (cSt) and a density of 0.86 kg/dm<sup>3</sup>.

For different pressure drop or fluid viscosity we recommend to use our selection software available on [www.mpfiltri.com](http://www.mpfiltri.com).

You can also calculate the right size using the formulas present on the FILTER SIZING paragraph at the beginning of the full catalogue or at the beginning of the filter family brochure. Please, contact our Sales Department for further additional information.

### Hydraulic symbols

Filter series	Style S	Style B	Style T	Style D	Style V	Style Z
<b>FZP 039</b>	•	•	•	•	•	•
<b>FZP 136</b>	•	•	-	-	-	-

### Pressure drop

Filter housings  $\Delta p$  pressure drop

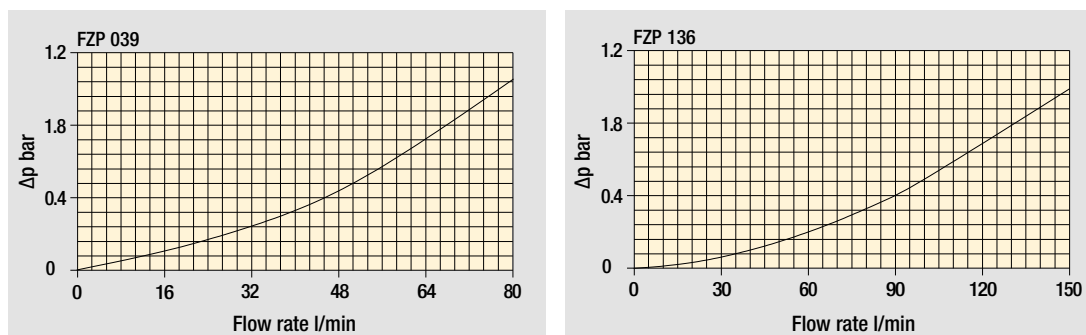

The curves are plotted using mineral oil with density of 0.86 kg/dm<sup>3</sup> in compliance with ISO 3968.  $\Delta p$  varies proportionally with density.

## Designation & Ordering code

### COMPLETE FILTER

Filter series and size **FZP039** Configuration example: **FZP039** **2** **B** **F** **B** **2** **A03** **U** **Z01** **EX**

**Filter length**  
**2** | **3** | **4** |

**Valves**  
**S** Without bypass      **D** With reverse flow, with bypass 6 bar  
**B** With bypass 6 bar      **V** With reverse flow, without bypass  
**T** With reverse flow, without bypass      **Z** With reverse flow, with bypass 6 bar

**Seals**  
**A** NBR  
**V** FPM  
**F** MFQ

**Connections**  
**A** G 1/2"  
**B** 1/2" NPT  
**C** SAE 8 - 3/4" - 16 UNF

**Connections for differential pressure indicator**  
**1** Without connection  
**2** With connection

**Filtration rating (filter media)**  
**A03** Inorganic microfiber 3 µm  
**A06** Inorganic microfiber 6 µm  
**A10** Inorganic microfiber 10 µm  
**A16** Inorganic microfiber 16 µm  
**A25** Inorganic microfiber 25 µm

Element Δp	S	B	T	D	V	Z
<b>R</b> 20 bar	-	•	-	•	-	•
<b>S</b> 210 bar	•	-	•	-	•	-
<b>U</b> 210 bar, stainless steel filter element	•	•	•	•	•	•

**Valves**

**Execution**  
**zerospark\***  
**Z01** MP Filtri standard  
**Zxx** Customized

**Certifications**  
**EX** ATEX certifications

### FILTER ELEMENT

Element series and size **HP039** Configuration example: **HP039** **2** **A03** **F** **U** **Z01**

**Element length**  
**2** | **3** | **4** |

**Filtration rating (filter media)**  
**A03** Inorganic microfiber 3 µm  
**A06** Inorganic microfiber 6 µm  
**A10** Inorganic microfiber 10 µm  
**A16** Inorganic microfiber 16 µm  
**A25** Inorganic microfiber 25 µm

**Seals**  
**A** NBR  
**V** FPM  
**F** MFQ

**Element Δp**  
**R** 20 bar  
**S** 210 bar  
**U** 210 bar, stainless steel filter element

**Execution**  
**zerospark\***  
**Z01** MP Filtri standard  
**Zxx** Customized

### CLOGGING INDICATORS

See page 719

**DEH** Electrical differential pressure indicator  
**DVX** Visual differential pressure indicator

**DVY** Visual differential pressure indicator

### PLUGS

See page 737

**X2** Stainless steel plug (not included)

FZP039	
Filter length	H [mm]
2	179
3	222
4	266
Connections	R
A	M6
B - C	1/4" UNC

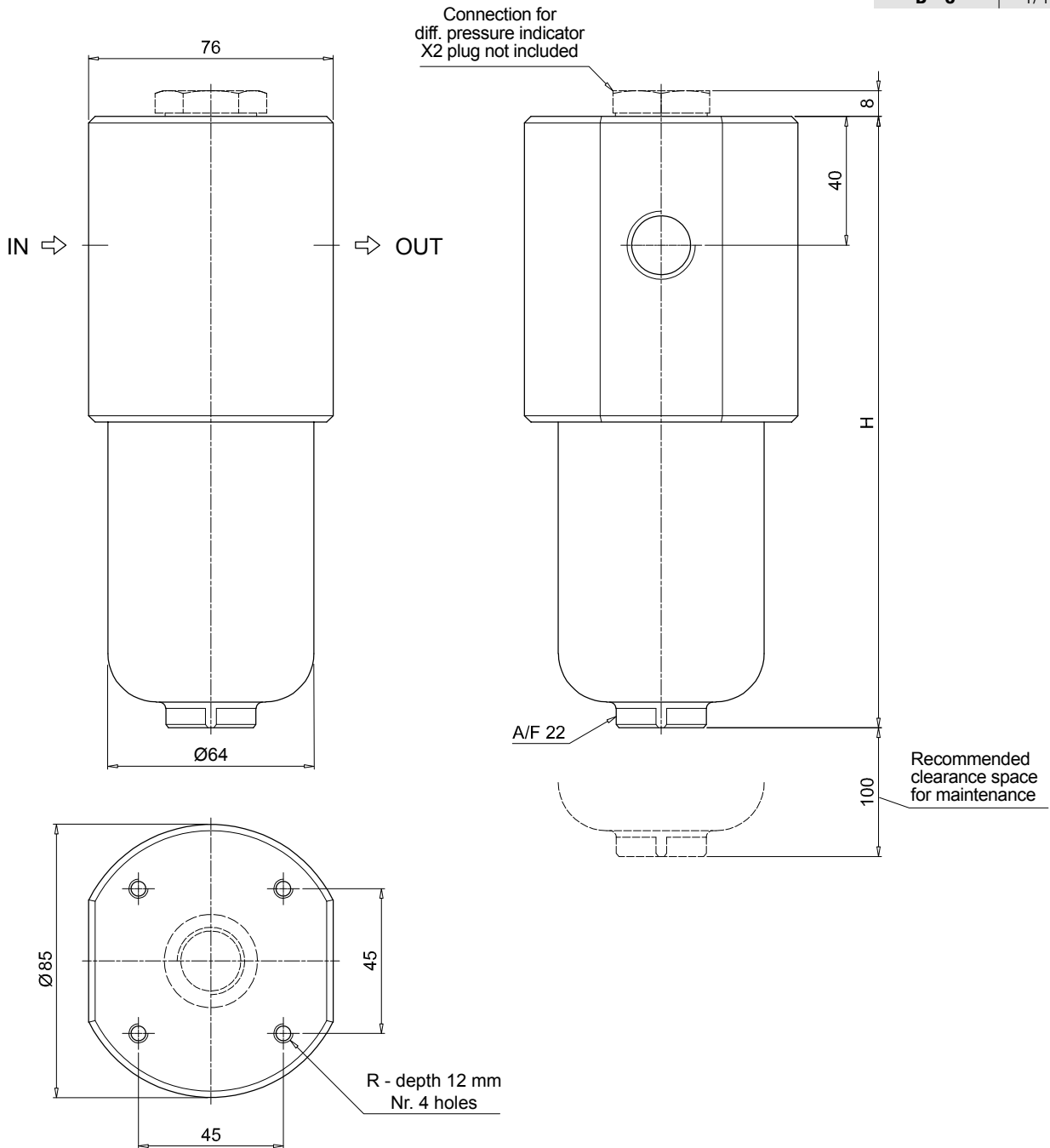

## Designation & Ordering code

### COMPLETE FILTER

Filter series and size **FZP136** Configuration example: **FZP136** | **1** | **B** | **A** | **B** | **6** | **A03** | **R** | **Z01** | **EX**

**Filter length**  
**1** | **2** | **3**

**Valves**  
**S** Without bypass  
**B** With bypass 6 bar

**Seals**  
**A** NBR  
**V** FPM  
**F** MFQ

**Connections**  
**A** G 3/4"      **G** G 1 1/4"  
**B** 3/4" NPT    **H** 1 1/4" NPT  
**C** SAE 12 - 1 1/16" - 12 UN    **I** SAE 20 - 1 5/8" - 12 UN  
**D** G 1"  
**E** 1" NPT  
**F** SAE 16 - 1 5/16" - 12 UN

**Connections for differential pressure indicator**  
**1** Without connection  
**6** With two connections on both sides

**Filtration rating (filter media)**  
**A03** Inorganic microfiber 3 µm  
**A06** Inorganic microfiber 6 µm  
**A10** Inorganic microfiber 10 µm  
**A16** Inorganic microfiber 16 µm  
**A25** Inorganic microfiber 25 µm

Element Δp	Valves	
	S	B
<b>R</b> 20 bar	-	•
<b>S</b> 210 bar	•	-
<b>U</b> 210 bar, stainless steel filter element	•	•

**Execution**  
**zerospark+**  
**Z01** MP Filtri standard  
**Zxx** Customized

**Certifications**  
**EX** ATEX certifications

### FILTER ELEMENT

Element series and size **HP135** Configuration example: **HP135** | **1** | **A03** | **A** | **R** | **Z01**

**Element length**  
**1** | **2** | **3**

**Filtration rating (filter media)**  
**A03** Inorganic microfiber 3 µm  
**A06** Inorganic microfiber 6 µm  
**A10** Inorganic microfiber 10 µm  
**A16** Inorganic microfiber 16 µm  
**A25** Inorganic microfiber 25 µm

**Seals**  
**A** NBR  
**V** FPM  
**F** MFQ

Element Δp	Valves	
	S	B
<b>R</b> 20 bar	-	•
<b>S</b> 210 bar	•	-
<b>U</b> 210 bar, stainless steel filter element	•	•

**Execution**  
**zerospark+**  
**Z01** MP Filtri standard  
**Zxx** Customized

### CLOGGING INDICATORS

**DEH** Electrical differential pressure indicator  
**DVX** Visual differential pressure indicator

**DVY** Visual differential pressure indicator

See page 719

### PLUGS

**X2** Stainless steel plug (not included)

See page 737

FZP136	
Filter length	H [mm]
<b>1</b>	222
<b>2</b>	335
<b>3</b>	410
Connections	R
<b>A</b>	M10
<b>B - C</b>	3/8" UNC
<b>D</b>	M10
<b>E - F</b>	3/8" UNC
<b>G</b>	M10
<b>H - I</b>	3/8" UNC

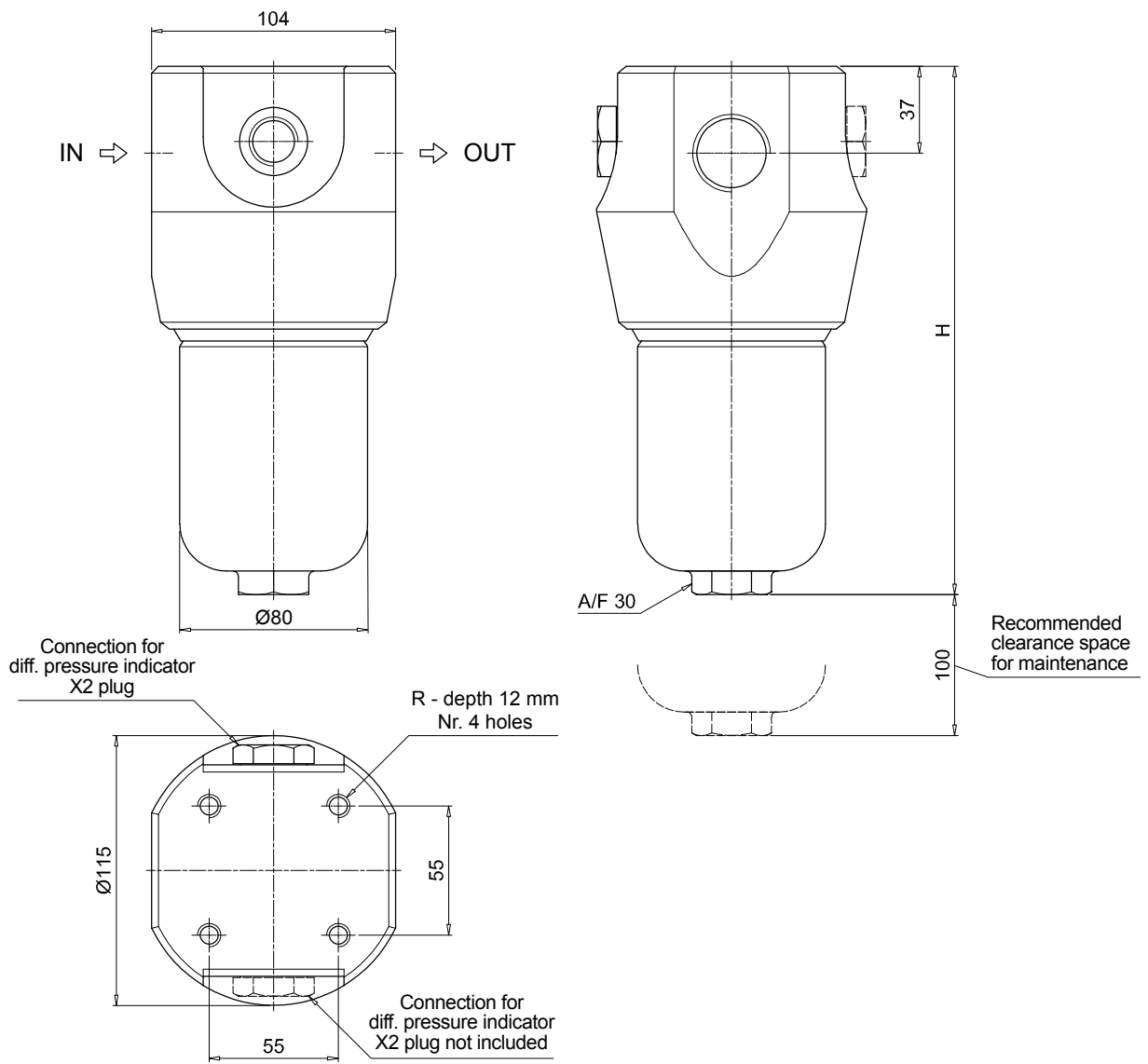

The position of the X2 plug is reversible

# FZP SPARE PARTS

Order number for spare parts

FZP 039

FZP 136

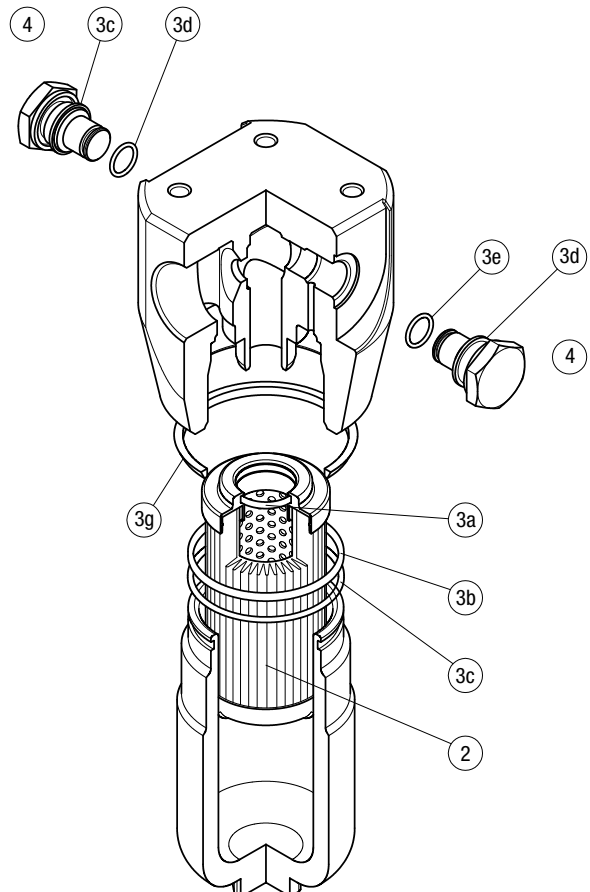
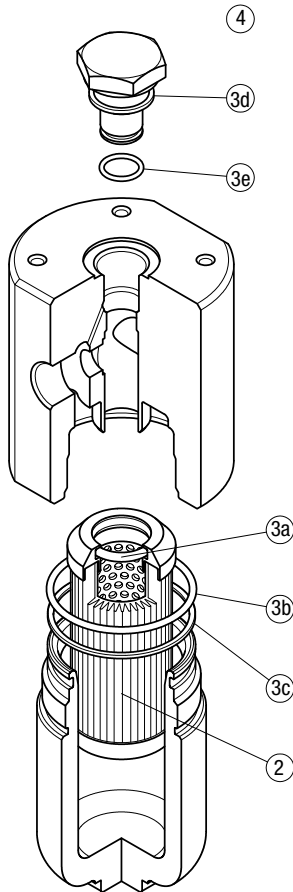

Item:	Q.ty: 1 pc.		Q.ty: 1 pc.		Q.ty: 1 pc.	
Filter series	Filter element	Seal Kit code number		Indicator connection plug		
FZP 039	See order table	NBR	FPM	NBR	FPM	
FZP 136	See order table	02050299	02050300	X2H	X2V	
		02050636	02050637			







# FZH series

Maximum working pressure up to 70 Mpa (700 bar) - Flow rate up to 80 l/min



## INSTALLATION, SERVICE AND MAINTENANCE MANUAL AND SAFETY INSTRUCTIONS



Please scan the QR codes  
to get updated electronic version  
of the related document.



## Description

## Technical data

### Filters for potentially explosive atmosphere

#### In-line

**Maximum working pressure up to 80 Mpa (700 bar)**

**Flow rate up to 80 l/min**

FZH is a range of stainless steel high pressure filter for protection of sensitive components in high pressure hydraulic systems placed in difficult environmental conditions.

They are directly connected to the lines of the system through the hydraulic fittings.

#### Available features:

- 1/2" female threaded connections, for a maximum flow rate of 80 l/min
- Fine filtration rating, to get a good cleanliness level into the system
- Bypass valve, to relieve excessive pressure drop across the filter media
- Low collapse filter element "N", for use with filters provided with bypass valve
- High collapse filter element "H", for use with filters not provided with bypass valve
- Low collapse filter element with external support "R", for filter element protection against the back pressure caused by the check valve or the reverse flow in filters provided with the bypass valve
- High collapse filter element with external support "S", for filter element protection against the back pressure caused by the check valve or the reverse flow in filters not provided with the bypass valve
- High collapse filter element "U", for use with aggressive fluids
- Visual, electrical and electronic differential clogging indicators

#### Common applications:

- Off-shore equipment
- Water filtration systems
- Systems with strong or corrosive environmental conditions
- Systems with corrosive fluids

#### Filter housing materials

- Head: AISI 316L
- Housing: AISI 316L
- Bypass valve: AISI 316L

#### Seals

- Standard NBR series A
- Optional FPM series V
- Optional MFQ series F

#### Bypass valve

Opening pressure 6 bar  $\pm$ 10%

#### Note

FZH filters are provided for vertical mounting

#### $\Delta p$ element type

Fluid flow through the filter element from OUT to IN

Microfibre filter elements - series N-R: 20 bar.

Element series "N - R":

- End cap: Polyamide
- Core tube: Tinned steel
- External/Internal support: Wire mesh Epoxy painted
- Media/Support/Pre-filter: Microfibre/Synthetic

Microfibre filter elements - series H-S: 210 bar.

Element series "H - S":

- End cap: Tinned steel
- Core tube: Tinned steel
- External support: Wire mesh Epoxy painted
- Internal support: Wire mesh Stainless steel
- Media/Support/Pre-filter: Microfibre/Synthetic

Stainless Steel Microfibre filter elements series U: 210 bar.

Element series "U":

- End cap: Stainless steel
- Core tube: Stainless steel
- External support: Stainless steel
- Internal support: Stainless steel
- Media/Support/Pre-filter: Microfibre/Synthetic

#### Temperature

Seals	Ambient Temperature	Max fluid Temperature	Temperature Class	Max surface temperature
NBR	-15 °C ÷ +80 °C	+80 °C	T6	T85 °C
FPM / MFQ	-15 °C ÷ +80 °C	+80 °C	T6	T85 °C
	-15 °C ÷ +95 °C	+95 °C	T5	T100 °C
	-15 °C ÷ +110 °C	+110 °C	T4	T115 °C

#### Filter with:

NBR seal in configuration **zerospark<sup>+</sup>**



II 3G Ex h IIC T6 Gc X  
II 3D Ex h IIIC T85°C Dc X

FPM / MFQ seal in configuration **zerospark<sup>+</sup>**



II 3G Ex h IIC T6... T4 Gc X  
II 3D Ex h IIIC T85°C...T115°C Dc X

## Weights [kg] and volumes [dm<sup>3</sup>]

Filter series	Weights [kg]					Volumes [dm <sup>3</sup> ]				
	Length	1	2	3	4	Length	1	2	3	4
<b>FZH 012</b>		2.1	2.2	2.7	3.3		0.10	0.12	0.15	0.20
<b>FZH 040</b>		-	4.5	5.1	5.6		-	0.19	0.26	0.34

Filter series	Length	Filter element design - N Series					Filter element design - H-U Series				
		A03	A06	A10	A16	A25	A03	A06	A10	A16	A25
<b>FZH 012</b>	<b>1</b>	4	6	8	9	11	3	5	6	7	9
	<b>2</b>	7	9	17	20	26	5	7	14	17	23
	<b>3</b>	11	14	25	27	32	11	14	24	27	32
	<b>4</b>	17	20	29	31	34	13	16	26	29	33

Filter series	Length	Filter element design - R Series					Filter element design - S-U Series				
		A03	A06	A10	A16	A25	A03	A06	A10	A16	A25
<b>FZH 040</b>	<b>2</b>	19	25	43	50	59	19	23	41	45	55
	<b>3</b>	34	37	53	62	74	31	34	48	52	66
	<b>4</b>	42	46	63	72	81	38	41	55	71	78

### Maximum flow rate for a complete stainless steel high pressure filter with a pressure drop $\Delta p = 1.5$ bar.

The reference fluid has a kinematic viscosity of 30 mm<sup>2</sup>/s (cSt) and a density of 0.86 kg/dm<sup>3</sup>.

For different pressure drop or fluid viscosity we recommend to use our selection software available on [www.mpfiltri.com](http://www.mpfiltri.com).

You can also calculate the right size using the formulas present on the FILTER SIZING paragraph at the beginning of the full catalogue or at the beginning of the filter family brochure. Please, contact our Sales Department for further additional information.

### Hydraulic symbols

Filter series	Style S	Style B	Style T	Style D	Style V	Style Z
<b>FZH 012</b>	•	•	-	-	•	•
<b>FZH 040</b>	•	•	•	•	•	•

### Pressure drop

Filter housings  $\Delta p$  pressure drop

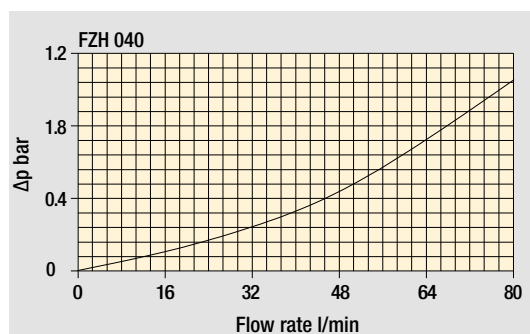
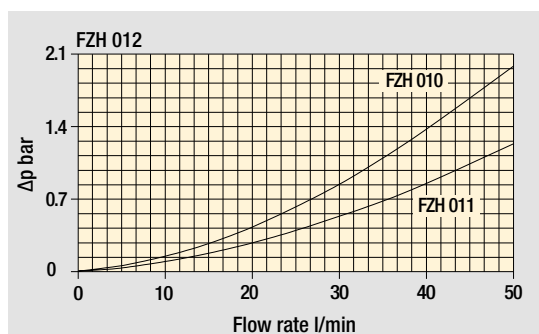

The curves are plotted using mineral oil with density of 0.86 kg/dm<sup>3</sup> in compliance with ISO 3968.  $\Delta p$  varies proportionally with density.

## Designation & Ordering code

### COMPLETE FILTER

Configuration example: **FZH012** | **2** | **B** | **F** | **B** | **2** | **A03** | **U** | **Z01** | **EX**

**Filter Series and size**  
**FZH012**

**Filter length**  
**1** | **2** | **3** | **4**

**Valves**  
**S** Without bypass  
**B** With bypass 6 bar  
**V** With reverse flow, without bypass  
**Z** With reverse flow, with bypass 6 bar

**Seals**  
**A** NBR  
**V** FPM  
**F** MFQ

**Connections**  
**A** G 1/4"  
**B** 1/4" NPT  
**C** SAE 5 - 1/2" - 20 UNF  
**D** G 3/8"  
**E** 3/8" NPT  
**F** SAE 6 - 9/16" - 18 UNF

**Connection for differential pressure indicator**  
**1** Without connection  
**2** With connection

Filtration rating (filter media)	Element $\Delta p$	Valves			
		S	B	V	Z
<b>A03</b> Inorganic microfiber 3 $\mu m$	<b>N</b> 20 bar	-	•	-	•
<b>A06</b> Inorganic microfiber 6 $\mu m$	<b>H</b> 210 bar	•	-	•	-
<b>A10</b> Inorganic microfiber 10 $\mu m$	<b>U</b> 210 bar, stainless steel filter element	•	•	•	•
<b>A16</b> Inorganic microfiber 16 $\mu m$					
<b>A25</b> Inorganic microfiber 25 $\mu m$					

**Execution**  
**zerospark+**  
**Z01** MP Filtri standard  
**Zxx** Customized

**Certifications**  
**EX** ATEX certifications

### FILTER ELEMENT

Configuration example: **HP011** | **2** | **A03** | **F** | **U** | **Z01**

**Element series and size**  
**HP011**

**Element length**  
**1** | **2** | **3** | **4**

Filtration rating (filter media)	
<b>A03</b> Inorganic microfiber	3 $\mu m$
<b>A06</b> Inorganic microfiber	6 $\mu m$
<b>A10</b> Inorganic microfiber	10 $\mu m$
<b>A16</b> Inorganic microfiber	16 $\mu m$
<b>A25</b> Inorganic microfiber	25 $\mu m$

**Seals**  
**A** NBR  
**V** FPM  
**F** MFQ

Element $\Delta p$	
<b>N</b>	20 bar
<b>H</b>	210 bar
<b>U</b>	210 bar, stainless steel filter element

**Execution**  
**zerospark+**  
**Z01** MP Filtri standard  
**Zxx** Customized

### CLOGGING INDICATORS

**DEZ** Electrical differential pressure indicator

**DVZ** Visual differential pressure indicator

See page 719

### PLUGS

**X3** Stainless steel plug (not included)

See page 737

FZH012	
Filter length	H [mm]
<b>1</b>	93
<b>2</b>	104
<b>3</b>	154
<b>4</b>	204

Connections	R
<b>A</b>	M6
<b>B - C</b>	1/4" UNC
<b>D</b>	M6
<b>E - F</b>	1/4" UNC



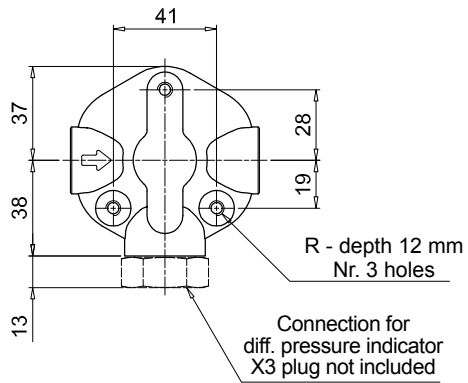
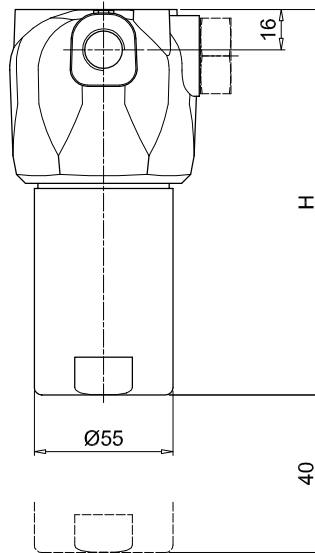
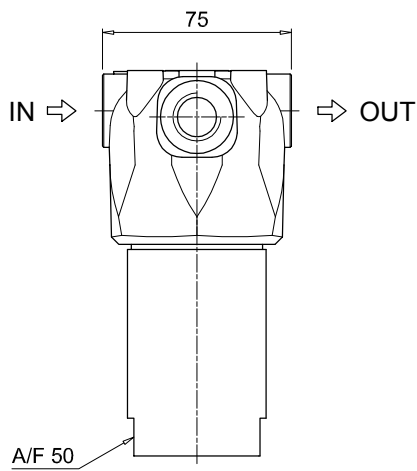

## Designation & Ordering code

### COMPLETE FILTER

Configuration example: **FZH040** | **2** | **T** | **A** | **A** | **2** | **A03** | **S** | **Z01** | **EX**

**Filter Series and size**  
**FZH040**

**Filter length**  
**2** | **3** | **4**

**Valves**  
**S** Without bypass  
**B** With bypass 6 bar  
**T** With check valve, without bypass  
**D** With check valve, with bypass 6 bar  
**V** With reverse flow, without bypass  
**Z** With reverse flow, with bypass 6 bar

**Seals**  
**A** NBR      **F** MFQ  
**V** FPM

**Connections**  
**A** G 1/2"  
**B** 1/2" NPT  
**C** SAE 8 - 3/4" - 16 UNF

**Connection for differential pressure indicator**  
**1** Without connection  
**2** With connection

**Filtration rating (filter media)**  
**A03** Inorganic microfiber 3 µm  
**A06** Inorganic microfiber 6 µm  
**A10** Inorganic microfiber 10 µm  
**A16** Inorganic microfiber 16 µm  
**A25** Inorganic microfiber 25 µm

Element Δp	Valves					
	S	B	T	D	V	Z
<b>R</b> 20 bar	-	•	-	•	-	•
<b>S</b> 210 bar	•	-	•	-	•	-
<b>U</b> 210 bar, stainless steel filter element	•	•	•	•	•	•

**Execution**  
**zerospark®**  
**Z01** MP Filtri standard  
**Zxx** Customized

**Certifications**  
**EX** ATEX certifications

### FILTER ELEMENT

Configuration example: **HP039** | **2** | **A03** | **A** | **S** | **Z01**

**Element series and size**  
**HP039**

**Element length**  
**2** | **3** | **4**

**Filtration rating (filter media)**  
**A03** Inorganic microfiber 3 µm  
**A06** Inorganic microfiber 6 µm  
**A10** Inorganic microfiber 10 µm  
**A16** Inorganic microfiber 16 µm  
**A25** Inorganic microfiber 25 µm

**Seals**  
**A** NBR  
**V** FPM  
**F** MFQ

**Element Δp**  
**R** 20 bar  
**S** 210 bar  
**U** 210 bar, stainless steel filter element

**Execution**  
**zerospark®**  
**Z01** MP Filtri standard  
**Zxx** Customized

### CLOGGING INDICATORS

See page 719

**DVZ** Visual differential pressure indicator

### PLUGS

See page 737

**X3** Stainless steel plug (not included)

Valves S - B - T - D

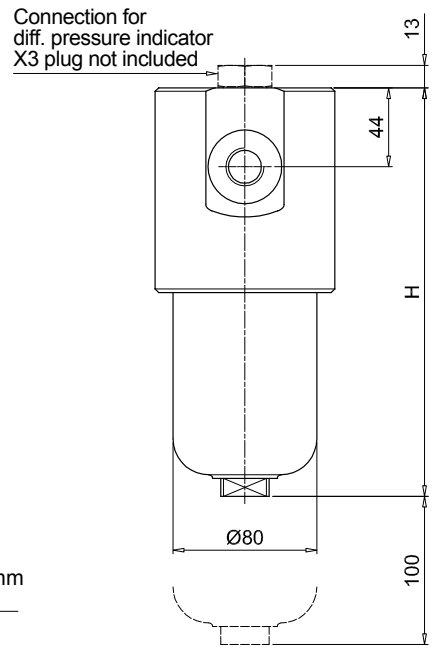
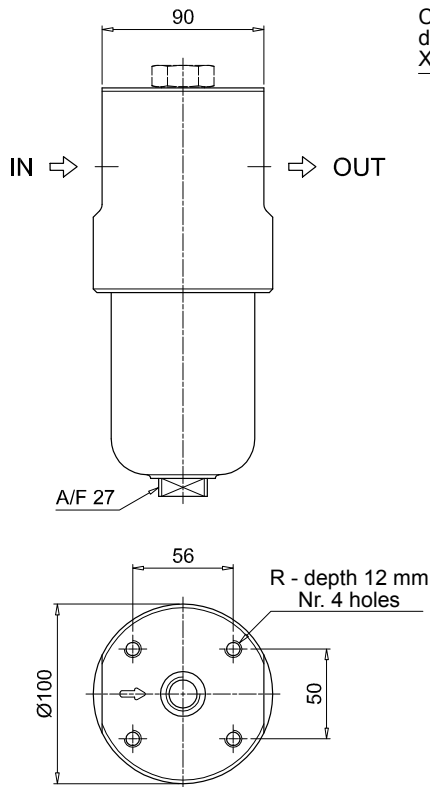

Recommended clearance space for maintenance

FZH040	
Filter length	H [mm]
2	204
3	247
4	291

Connections	R
A	M10
B	3/8" UNC
C	3/8" UNC

Valves V - Z

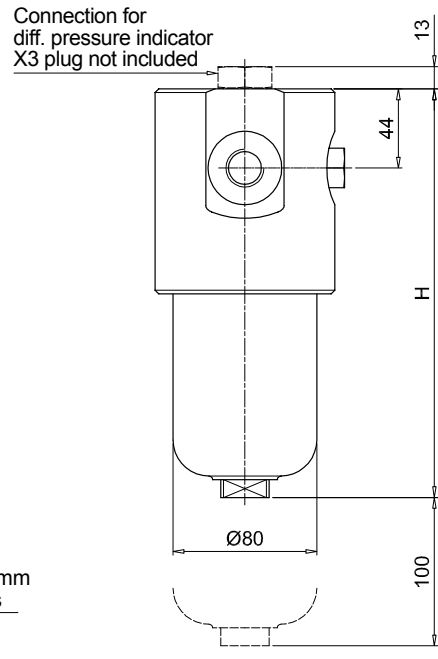
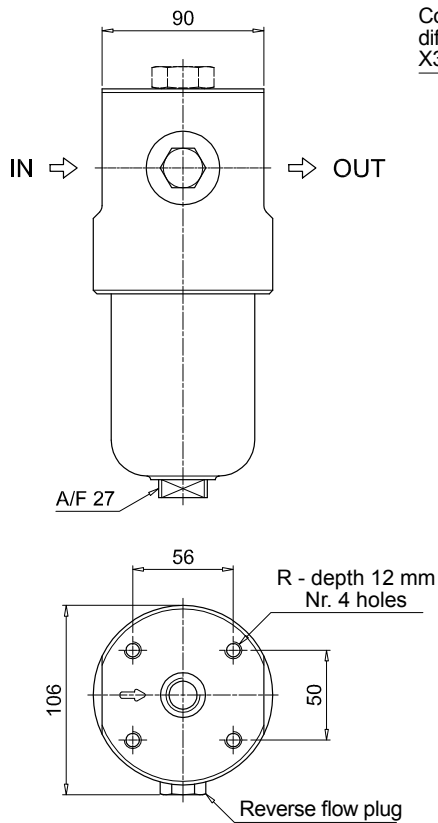

Recommended clearance space for maintenance

# FZH SPARE PARTS

Order number for spare parts

FZH 012

FZH 040

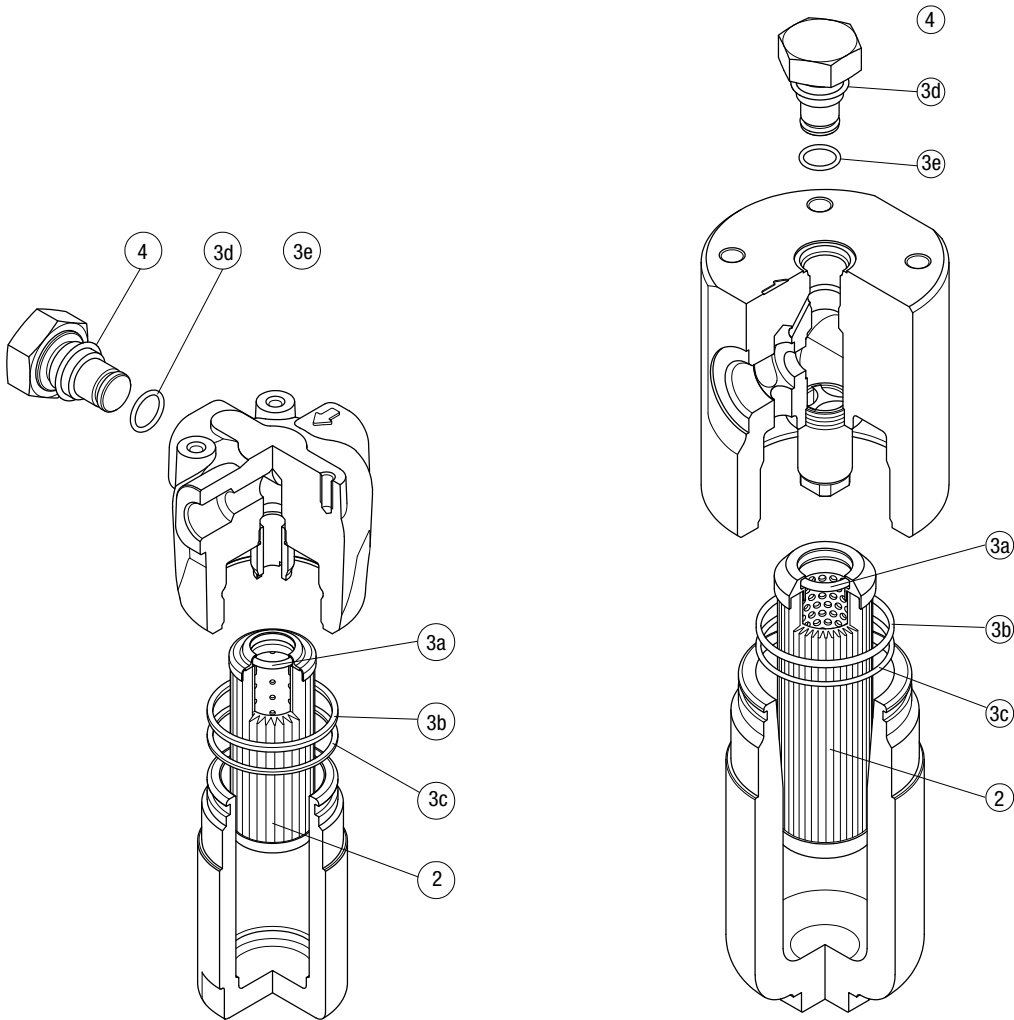

Item:	Q.ty: 1 pc.	Q.ty: 1 pc.		Q.ty: 1 pc.	
Filter series	Filter element	Seal Kit code number		Indicator connection plug	
FZH 012	See order table	NBR	FPM	NBR	FPM
FZH 040	See order table	02050856	02050857	X2H	X2V
		02050860	02050861		





# FZX series

Maximum working pressure up to 100 Mpa (1000 bar) - Flow rate up to 10 l/min



## INSTALLATION, SERVICE AND MAINTENANCE MANUAL AND SAFETY INSTRUCTIONS



Please scan the QR codes  
to get updated electronic version  
of the related document.





## Description

## Technical data

### Filters for potentially explosive atmosphere

#### In-line

**Maximum working pressure up to 100 Mpa (1000 bar)**  
**Flow rate up to 10 l/min**

FZX is a range of stainless steel high pressure filter for protection of sensitive components in high pressure hydraulic systems placed in difficult environmental conditions.

They are directly connected to the lines of the system through the hydraulic fittings.

#### Available features:

- 1/2" female threaded connections, for a maximum flow rate of 10 l/min
- Fine filtration rating, to get a good cleanliness level into the system
- High collapse filter element "H", for use with filters not provided with bypass valve
- High collapse filter element "U", for use with aggressive fluids

#### Common applications:

- Off-shore equipment
- Water filtration systems
- Systems with strong or corrosive environmental conditions
- Systems with corrosive fluids

### Filter housing materials

- Head: AISI 316L
- Housing: AISI 316L
- Bypass valve: AISI 316L

### Seals

- Standard NBR series A
- Optional FPM series V
- Optional MFQ series F

### Bypass valve

Opening pressure 6 bar  $\pm$ 10%

### Note

FZX filters are provided for vertical mounting

### $\Delta p$ element type

Fluid flow through the filter element from OUT to IN

Microfibre filter elements - series H: 210 bar.

Element series "H":

- End cap: Tinned steel
- Core tube: Tinned steel
- External support: Wire mesh Epox painted
- Internal support: Wire mesh Stainless steel
- Media/Support/Pre-filter: Microfibre/Syntetic

Stainless Steel Microfibre filter elements series U: 210 bar.

Element series "U":



- End cap: Stainless steel
- Core tube: Stainless steel
- External support: Stainless steel
- Internal support: Stainless steel
- Media/Support/Pre-filter: Microfibre/Syntetic

### Temperature



Seals	Ambient Temperature	Max fluid Temperature	Temperature Class	Max surface temperature
NBR	-15 °C ÷ +80 °C	+80 °C	T6	T85 °C
FPM / MFQ	-15 °C ÷ +80 °C	+80 °C	T6	T85 °C
	-15 °C ÷ +95 °C	+95 °C	T5	T100 °C
	-15 °C ÷ +110 °C	+110 °C	T4	T115 °C

### Filter with:

NBR seal in configuration **zerospark<sup>®</sup>**

   II 3G Ex h IIC T6 Gc X  
 II 3D Ex h IIIC T85°C Dc X

FPM / MFQ seal in configuration **zerospark<sup>®</sup>**

   II 3G Ex h IIC T6... T4 Gc X  
 II 3D Ex h IIIC T85°C...T115°C Dc X

## Weights [kg] and volumes [dm<sup>3</sup>]

Filter series	Weights [kg]					Volumes [dm <sup>3</sup> ]				
	Length	1	2	3	4	Length	1	2	3	4
<b>FZX 011</b>	-	-	6.5	-	-	-	-	-	0.15	-

Filter series	Length	Filter element design - H-U Series				
		A03	A06	A10	A16	A25
<b>FZX 011</b>	<b>3</b>	1.57	1.63	1.73	1.74	1.77

### Maximum flow rate for a complete stainless steel high pressure filter with a pressure drop $\Delta p = 1.5$ bar.

The reference fluid has a kinematic viscosity of 30 mm<sup>2</sup>/s (cSt) and a density of 0.86 kg/dm<sup>3</sup>.

For different pressure drop or fluid viscosity we recommend to use our selection software available on [www.mpfiltri.com](http://www.mpfiltri.com).

You can also calculate the right size using the formulas present on the FILTER SIZING paragraph at the beginning of the full catalogue or at the beginning of the filter family brochure. Please, contact our Sales Department for further additional information.

## Hydraulic symbols

Filter series	Style S
<b>FZX 011</b>	•

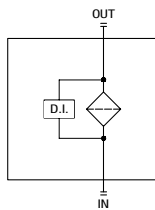

## Pressure drop

Filter housings  $\Delta p$  pressure drop

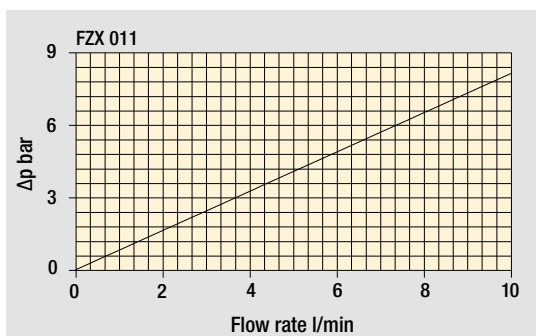

The curves are plotted using mineral oil with density of 0.86 kg/dm<sup>3</sup> in compliance with ISO 3968.  $\Delta p$  varies proportionally with density.

## Designation & Ordering code

### COMPLETE FILTER

<b>Filter series and size</b>	Configuration example: <b>FZX011</b>	<b>3</b>	<b>S</b>	<b>V</b>	<b>B</b>	<b>1</b>	<b>A03</b>	<b>U</b>	<b>Z01</b>	<b>EX</b>
<b>FZX011</b>										
<b>Filter length</b>										
<b>3</b>										
<b>Bypass valve</b>										
<b>S Without bypass</b>										
<b>Seals</b>										
<b>A NBR</b>										
<b>V FPM</b>										
<b>F MFQ</b>										
<b>Connections</b>										
<b>700 bar</b>										
<b>A G 1/4"</b>										
<b>B 1/4" NPT</b>										
<b>G G 1/2"</b>										
<b>H 1/2" NPT"</b>										
<b>Autoclave 1000 bar</b>										
<b>M 9/16" - 18 UNF</b>										
<b>L 3/4" - 14 NPS</b>										
<b>Connection for differential pressure indicator</b>										
<b>1 Without connection</b>										
<b>Filtration rating (filter media)</b>										
<b>A03 Inorganic microfiber 3 µm</b>										
<b>A06 Inorganic microfiber 6 µm</b>										
<b>A10 Inorganic microfiber 10 µm</b>										
<b>A16 Inorganic microfiber 16 µm</b>										
<b>A25 Inorganic microfiber 25 µm</b>										
<b>Element Δp</b>										
<b>H 210 bar</b>										
<b>U 210 bar, stainless steel filter element</b>										
<b>Execution</b>										
<b>zerospark®</b>										
<b>Z01 MP Filtri standard</b>										
<b>Zxx Customized</b>										
<b>Certifications</b>										
<b>EX ATEX certifications</b>										

### FILTER ELEMENT

<b>Element series and size</b>	Example: <b>HP011</b>	<b>3</b>	<b>A03</b>	<b>V</b>	<b>U</b>	<b>Z01</b>
<b>HP011</b>						
<b>Element length</b>						
<b>3</b>						
<b>Filtration rating (filter media)</b>						
<b>A03 Inorganic microfiber 3 µm</b>						
<b>A06 Inorganic microfiber 6 µm</b>						
<b>A10 Inorganic microfiber 10 µm</b>						
<b>A16 Inorganic microfiber 16 µm</b>						
<b>A25 Inorganic microfiber 25 µm</b>						
<b>Seals</b>						
<b>A NBR</b>						
<b>V FPM</b>						
<b>F MFQ</b>						
<b>Element Δp</b>						
<b>H 210 bar</b>						
<b>U 210 bar, stainless steel filter element</b>						
<b>Execution</b>						
<b>zerospark®</b>						
<b>Z01 MP Filtri standard</b>						
<b>Zxx Customized</b>						

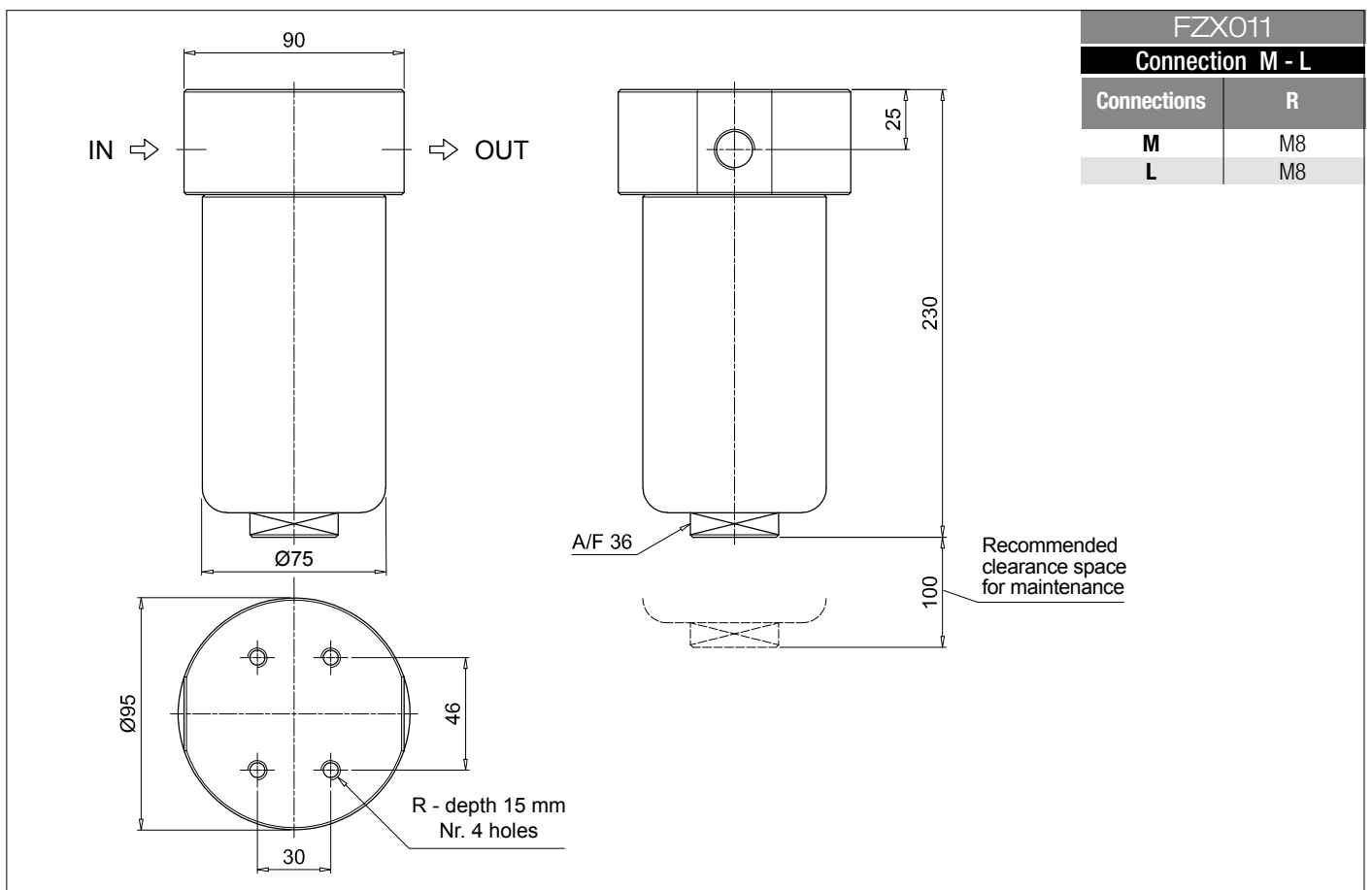
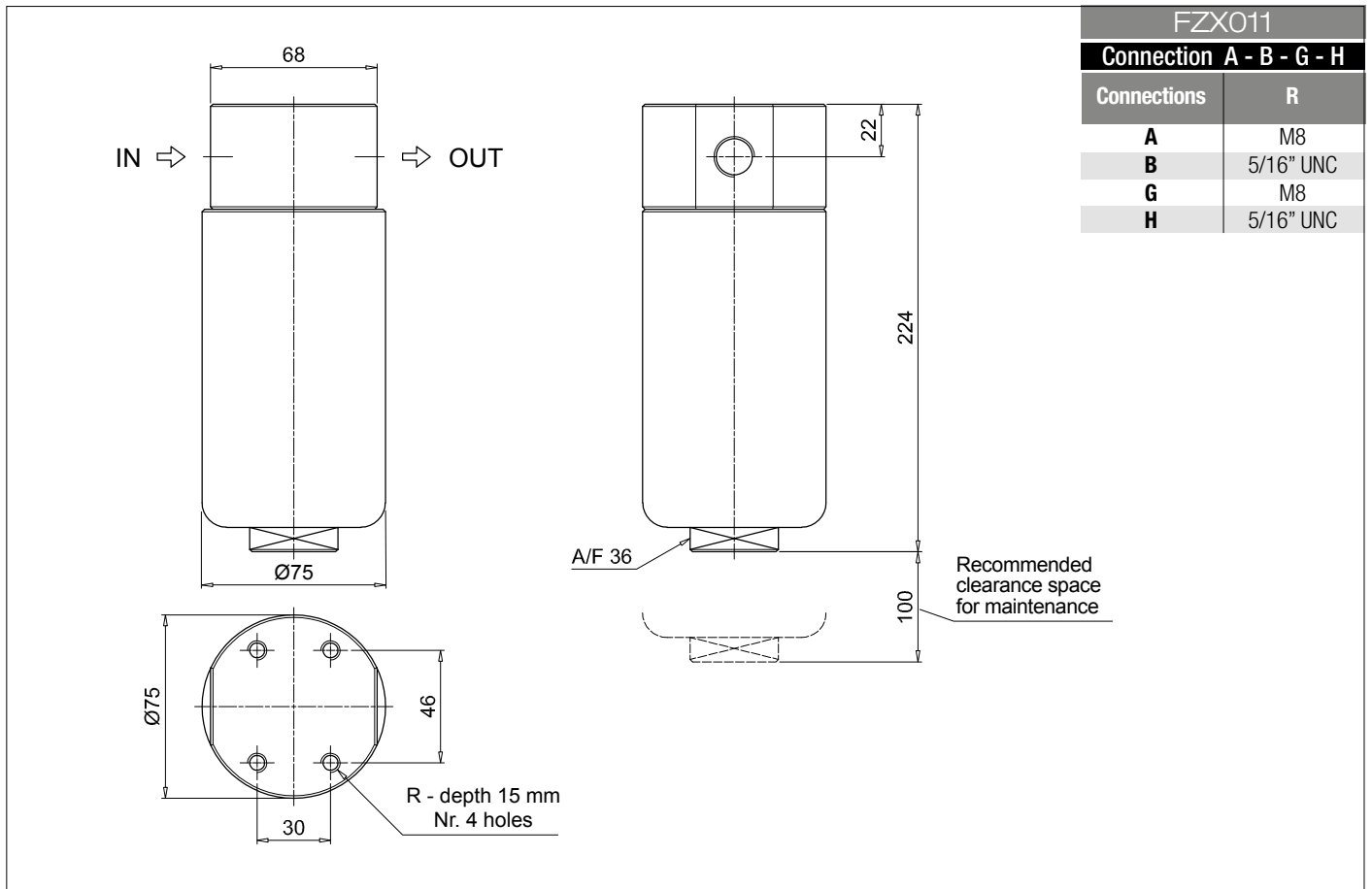

Order number for spare parts

**FZX 011**

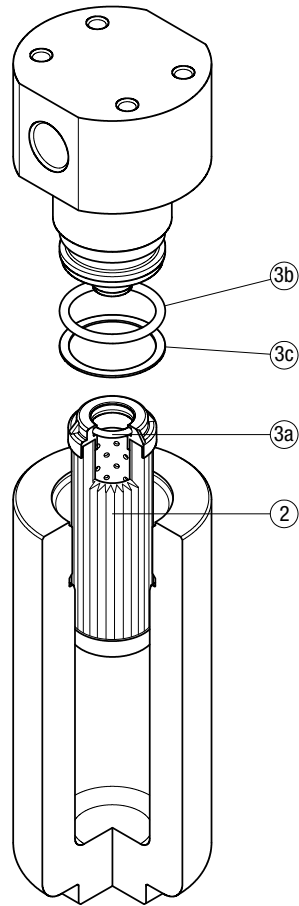

Item:	Q.ty: 1 pc.	Q.ty: 1 pc.	
Filter series	Filter element	Seal Kit code number	
FZX 011	See order table	NBR	FPM
	<b>2</b>	02050643	02050644
			<b>3</b> (3a ÷ 3c)







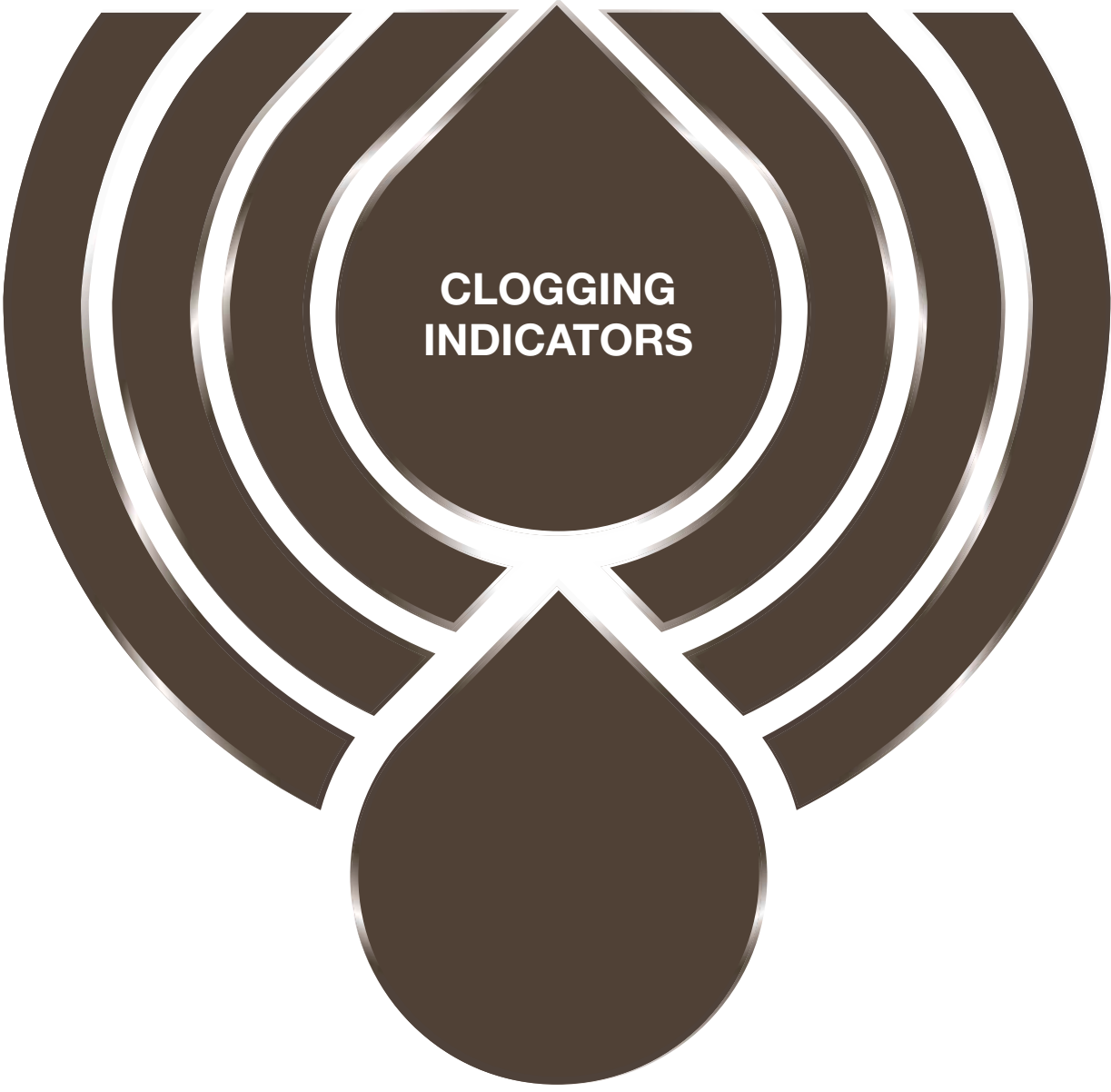

**CLOGGING  
INDICATORS**

Clogging indicators are devices that check the life time of the filter elements. They measure the pressure drop through the filter element directly connected to the filter housing.

These devices trip when the clogging of the filter element causes a pressure drop increasing across the filter element.

Filter elements are efficient only if their Dirt Holding Capacity is fully exploited. This is achieved by using filter housings equipped with clogging indicators.

The indicator is set to alarm before the element becomes fully clogged.

MP Filtri can supply indicators of the following designs:

- Vacuum switches and gauges
- Pressure switches and gauges
- Differential pressure indicators

These type of devices can be provided with a visual, electrical or both signals. The electronic differential pressure clogging indicator is also available. It provides both analogical 4-20 mA output and digital warning (75% of clogging) and alarm (clogging) outputs.

In the following pages you can find a reference guide about the types of clogging indicators available in the different families of MP Filtri's Hydraulic Filtration range of products.



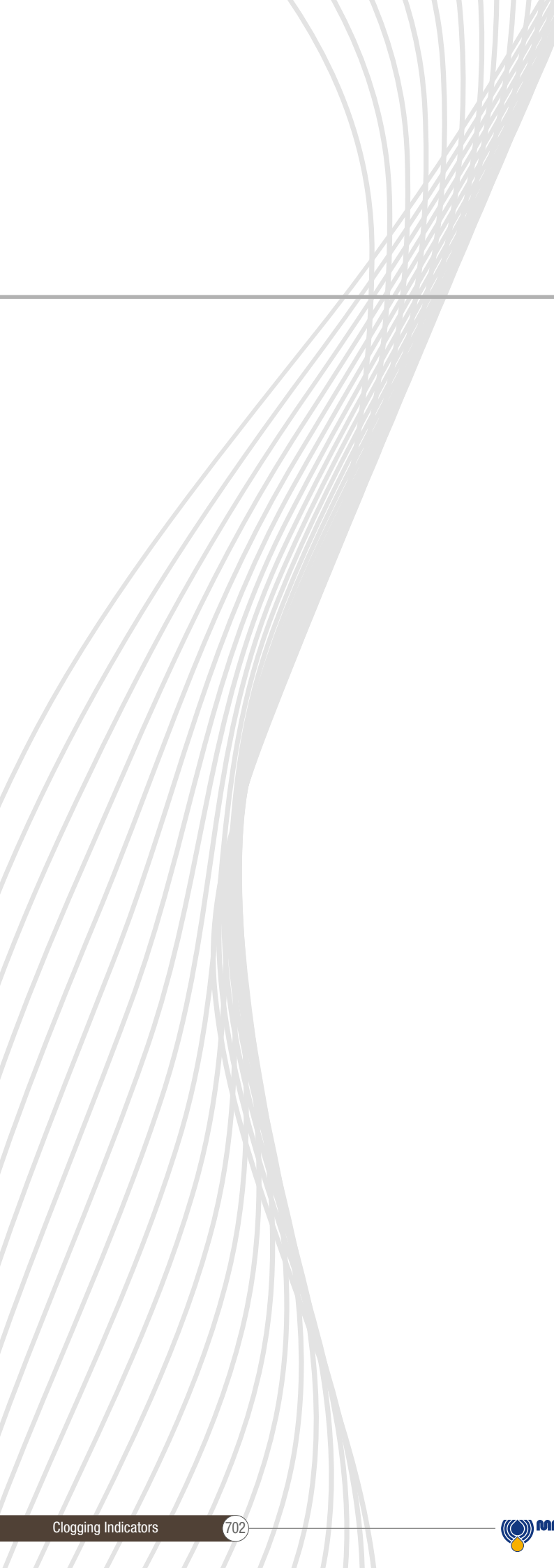

# DESIGNATION, ORDERING CODES & TECHNICAL DATA

## INDEX

	Page
QUICK REFERENCE GUIDE	704
<b>CLOGGING INDICATORS ORDERING CODES</b>	
SUCTION FILTERS INDICATORS	709
RETURN FILTERS INDICATORS	710
RETURN / SUCTION FILTERS INDICATORS	712
SPIN-ON FILTERS INDICATORS	714
LOW & MEDIUM PRESSURE FILTERS INDICATORS	716
HIGH PRESSURE FILTERS INDICATORS	717
STAINLESS STEEL HIGH PRESSURE FILTERS INDICATORS	718
FILTERS FOR POTENTIALLY EXPLOSIVE ATMOSPHERE INDICATORS	719
<b>TECHNICAL DATA</b>	
VACUUM INDICATORS	720
BAROMETRIC (PRESSURE) INDICATORS	722
DIFFERENTIAL PRESSURE INDICATORS	726
PLUGS	737

# QUICK REFERENCE GUIDE

## Ordering codes

Filter family	Filter series	Visual indicators	Electrical indicators	Electronic / Electrical-Visual indicators
SUCTION FILTERS	<b>ELIXIR®</b> SFEX060-080-110-160	VVB20P01 VVS20P01	VEB21AA50P01	VLB21AA51P01 VLB21AA52P01 VLB21AA53P01 VLB21AA71P01
	With bypass valve 0.3 bar	SF2 250 - 350 SF2 500 - 501 - 503 - 504 - 505 SF2 510 - 535 - 540	WA20P01 WR20P01	VEA21xA50P01 VEA21xA50P01UL
RETURN FILTERS	<b>ELIXIR®</b> RFEX060-080-110-160	BVA14P01 BVR14P01 BVP15HP01 BVQ15HP01	BEA15HA50P01 BEA15HA50P01UL BEM15HA41P01	BLA15HA51P01 BLA15HA52P01 BLA15HA53P01 BLA15HA71P01
	With bypass 1.75 bar			
	<b>ELIXIR®</b> RFEX060-080-110-160	BVA25P01 BVR25P01 BVP20HP01 BVQ20HP01	BEA20HA50P01 BEA20HA50P01UL BEM20HA41P01	BLA20HA51P01 BLA20HA52P01 BLA20HA53P01 BLA20HA71P01
	Without bypass			
	MDH 250	BVA14P01 BVR14P01 BVP15HP01 BVQ15HP01 DVS12HP01	BEA15HA50P01 BEA15HA50P01UL BEM15HA41P01 DES12HA10P01 DES12HA30P01 DES12HA80P01	BLA15HA51P01 BLA15HA52P01 BLA15HA53P01 BLA15HA71P01
	With bypass 1.75 bar			
	MDH 250	BVA25P01 BVR25P01 BVP20HP01 BVQ20HP01 DVS25HP01	BEA20HA50P01 BEA20HA50P01UL BEM20HA41P01 DES25HA10P01 DES25HA30P01 DES25HA80P01	BLA20HA51P01 BLA20HA52P01 BLA20HA53P01 BLA20HA71P01
	With bypass 3 bar			
	MPFX MPTX MPF MPT MPH	BVA14P01 BVR14P01 BVP15HP01 BVQ15HP01	BEA15HA50P01 BEA15HA50P01UL BEM15HA41P01	BLA15HA51P01 BLA15HA52P01 BLA15HA53P01 BLA15HA71P01
	With bypass 1.75 bar			
MPFX MPTX MPF MPT	BVA25P01 BVR25P01 BVP20HP01 BVQ20HP01	BEA20HA50P01 BEA20HA50P01UL BEM20HA41P01	BLA20HA51P01 BLA20HA52P01 BLA20HA53P01 BLA20HA71P01	
With bypass 3 bar				
MPH				
With bypass 2.5 bar				
MPLX	DVA20xP01 DVM20xP01	DEA20xA50P01 DEA20xA50P01UL DEM20xx10P01 DEM20xx20P01 DEM20xx30P01 DEM20xx35P01 DEU20xA50P01UL	DLA20xA51P01 DLA20xA52P01 DLA20xA71P01 DLE20xA50P01 DLE20xF50P01 DTA20xF70P01	
With bypass 4.5 bar				
FRI				
With bypass 2.4 bar				

Filter family	Filter series	Visual indicators	Electrical indicators	Electronic / Electrical-Visual indicators		
RETURN / SUCTION FILTERS	MRSX 116 - 165 - 166 Suction line	VVB20P01	VEB21AA50P01	VLB21AA51P01 VLB21AA52P01 VLB21AA53P01 VLB21AA71P01		
		VVS20P01				
	With bypass valve 2.5 bar	MRSX 116 - 165 - 166 Return line	BVA25P01	BEA20HA50P01 BEA20HA50P01UL	BLA20HA51P01 BLA20HA52P01 BLA20HA53P01 BLA20HA71P01	
			BVR25P01	BEM20HA41P01		
	With bypass valve 2.5 bar	LMP 124 MULTIPORT	BVP20HP01	BET25HF10P01 BET25HF30P01 BET25HF50P01	DLA20xA51P01 DLA20xA52P01 DLA20xA71P01 DLE20xA50P01 DLE20xF50P01	
			BVQ20HP01	DEA20xA50P01		
			DVA20xP01	DEM20xx10P01 DEM20xx20P01 DEM20xx30P01 DEM20xx35P01		
			DVM20xP01	DEU20xA50P01UL		
			BVA25P01	BEM20HA41P01		BLA20HA51P01 BLA20HA52P01 BLA20HA53P01 BLA20HA71P01
			BVR25P01	BET25HF10P01 BET25HF30P01 BET25HF50P01		
SPIN-ON FILTERS	Suction line	MPS 050 - 070 - 100 - 150	WB20P01	VEB21AA50P01		
		MPS 200 - 250 - 300 - 350			VVS20P01	
	Return line	MPS 050 - 070 - 100 - 150 MPS 200 - 250 - 300 - 350 MST 050 - 070 - 100 - 150	BVA14P01	BEA15HA50P01	BLA15HA51P01 BLA15HA52P01 BLA15HA53P01 BLA15HA71P01	
			BVR14P01	BEA15HA50P01UL		
			BVP15HP01	BEM15HA41P01		
			BVQ15HP01			
	In-line	MPS 051 - 071 - 101 - 151 MPS 301 - 351 MSH 050 - 070 - 100 - 150	DVA12xP01	DEA12xA50P01	DLA12xA51P01 DLA12xA52P01 DLA12xA71P01 DLE12xA50P01 DLE12xF50P01 DLE20xF50P01 DLE20xF50P01	
			DVM12xP01	DEM12xAxxP01 DEU20xA50P01UL		DTA12xF70P01 DTA20xF70P01



# QUICK REFERENCE GUIDE

## Ordering codes

Filter family	Filter series	Visual indicators	Electrical indicators	Electronic / Electrical-Visual indicators		
LOW & MEDIUM PRESSURE FILTERS	ELIXIR® LFEX060-080-110-160	DVS25HP01	DES25HA10P01 DES25HA30P01 DES25HA80P01			
	With bypass valve 3.5 bar	LMP 110 LMP 112 - 116 - 118 - 119 MULTIPORT LMP 120 - 122 - 123 MULTIPORT LMP 210 - 211 - LDP LMP 400 - 401 & 430 - 431 LMP 900 - 901 LMP 902 - 903	DVA20xP01 DVM20xP01	DEA20xA50P01 DEM20xx10P01 DEM20xx20P01 DEM20xx30P01 DEM20xx35P01 DEU20xA50P01UL	DLA20xA51P01 DLA20xA52P01 DLA20xA71P01 DLE20xA50P01 DLE20xF50P01 DTA20xF70P01	
	With bypass valve 2.5 bar	LPH 630	DVA20xP01 DVM20xP01	DEA20xA50P01 DEM20xx10P01 DEM20xx20P01 DEM20xx30P01 DEM20xx35P01 DEU20xA50P01UL	DLA20xA51P01 DLA20xA52P01 DLA20xA71P01 DLE20xA50P01 DLE20xF50P01 DTA20xF70P01	
	With bypass valve 1.75 bar	LPH 630	DVA12xP01 DVM12xP01 DVS12HP01	DEA12xA50P01 DEM12xx10P01 DEM12xx20P01 DEM12xx30P01 DEM12xx35P01	DLA12xA51P01 DLA12xA52P01 DLA12xA71P01 DLE12xA50P01 DLE12xF50P01 DTA12xF70P01	
	HIGH PRESSURE FILTERS	ELIXIR® LFEX060-080-110-160	DVS40HP01	DES40HA10P01 DES40HA30P01 DES40HA80P01		
		Without bypass valve	LMP 110 LMP 112 - 116 - 118 - 119 MULTIPORT LMP 120 - 122 - 123 MULTIPORT LMP 210 - 211 - LDP LMP 400 - 401 & 430 - 431 LMP 900 - 901 LMP 902 - 903 LMP 950 - 951 LMP 952 - 953 - 954 LMD 211 - 400 - 401 - 431 - 951 - LDD LPH 630	DVA50xP01 DVM50xP01	DEA50xA50P01 DEM50xx10P01 DEM50xx20P01 DEM50xx30P01 DEM50xx35P01 DEU50xA50P01UL	DLA50xA51P01 DLA50xA52P01 DLA50xA71P01 DLE50xA50P01 DLE50xF50P01 DTA50xF70P01
		With bypass valve 6 bar	FMP 039 - 065 - 135 - 320 FHP 010 - 011 - 065 - 135 - 350 - 351 - 500 FMMX 050 FMM 050 - 150 FHA 051 FHM 006 - 007 - 010 - 050 - 065 - 135 - 320 - 500 FHB 050 - 135 - 320 FHF 325 FHD 021 - 051 - 326 - 333	DVA50xP01 DVM50xP01	DEA50xA50P01 DEM50xx10P01 DEM50xx20P01 DEM50xx30P01 DEM50xx35P01 DEU50xA50P01UL	DLA50xA51P01 DLA50xA52P01 DLA50xA71P01 DLE50xA50P01 DLE50xF50P01
		Without bypass valve	FMP 039 - 065 - 135 - 320 FHP 010 - 011 - 065 - 135 - 350 - 351 - 500 FMMX 050 FMM 050 - 150 FHA 051 FHM 006 - 007 - 010 - 050 - 065 - 135 - 320 - 500 FHB 050 - 135 - 320 FHF 325 FHD 021 - 051 - 326 - 333	DVA70xP01 DVA95xP01 DVM70xP01 DVM95xP01	DEA70xA50P01 DEA95xA50P01 DEM70xx10P01 DEM70xx20P01 DEM70xx30P01 DEM70xx35P01 DEU70xA50P01UL DEM95xx10P01 DEM95xx20P01 DEM95xx30P01 DEM95xx35P01	DLA70xA51P01 DLA70xA52P01 DLA70xA71P01 DLA95xA51P01 DLA95xA52P01 DLA95xA71P01 DLE70xA50P01 DLE70xF50P01 DLE95xA50P01 DLE95xF50P01 DTA70xF70P01 DTA95xF70P01

Filter family	Filter series	Visual indicators	Electrical indicators	Electronic / Electrical-Visual indicators
STAINLESS STEEL HIGH PRESSURE FILTERS	With bypass valve 6 bar	FZH 012 - 040	DVZ50xP01	DEZ50xA50P01 DLZ50xA51P01 DLZ50xA52P01
	Without bypass valve	FZH 012 - 040	DVZ70xP01 DVZ95xP01	DEZ70xA50P01 DEZ95xA50P01 DLZ70xA51P01 DLZ70xA52P01 DLZ95xA51P01 DLZ95xA52P01
	With bypass valve 6 bar	FZP 039 - 136 FZB 039 FZM 039 FZD 051	DVX50xP01 DZY50xP01	DEX50xA50P01 DLX50xA51P01 DLX50xA52P01
	Without bypass valve	FZP 039 - 136 FZB 039 FZM 039 FZD 010 - 021 - 051	DVX70xP01 DVX95xP01 DZY70xP01 DZY95xP01	DEX70xA50P01 DEX95xA50P01 DLX70xA51P01 DLX70xA52P01 DLX95xA51P01 DLX95xA52P01
	With bypass valve 6 bar	FMMX 050	DVA50xP01 DVM50xP01	DEH50xA48P01 DEH50xA49P01 DEH50xA70P01
	Without bypass valve	FMMX 050	DVA70xP01 DVA95xP01 DVM70xP01 DVM95xP01	DEH70xA48P01 DEH70xA49P01 DEH70xA70P01 DEH95xA48P01 DEH95xA49P01 DEH95xA70P01
	With bypass valve 6 bar	FZP 039 - 136	DVX50xP01 DZY50xP01	DEH50xA48P01 DEH50xA49P01 DEH50xA70P01
	Without bypass valve	FZP 039 - 136	DVX70xP01 DVX95xP01 DZY70xP01 DZY95xP01	DEH70xA48P01 DEH70xA49P01 DEH70xA70P01 DEH95xA48P01 DEH95xA49P01 DEH95xA70P01
FILTERS FOR POTENTIALLY EXPLOSIVE ATMOSPHERE	With bypass valve 6 bar	FZH 012 - 040	DVZ50xP01	
	Without bypass valve	FZH 012 - 040	DVZ70xP01 DVZ95xP01	

Suitable indicator types

**V ACUUM INDICATORS**

Vacuum indicators are used on the Suction line to check the efficiency of the filter element.

They measure the pressure downstream of the filter element.

Standard items are produced with R 1/4" EN 10226 connection.

Available products with R 1/8" EN 10226 to be fitted on MPS series.

Vacuum indicators are identified in the Hydraulic Filtration catalogue and in the Quick Reference Guide table by the letter "V".

Example:

**V** VVB20P01

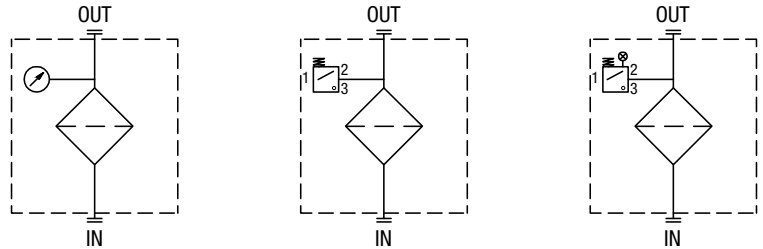

**B BAROMETRIC (PRESSURE) INDICATORS**

Pressure indicators are used on the Return line to check the efficiency of the filter element.

They measure the pressure upstream of the filter element.

Standard items are produced with R 1/8" EN 10226 connection.

Barometric (pressure) indicators are identified in the Hydraulic Filtration catalogue and in the Quick Reference Guide table by the letter "B".

Example:

**B** BVA14P01

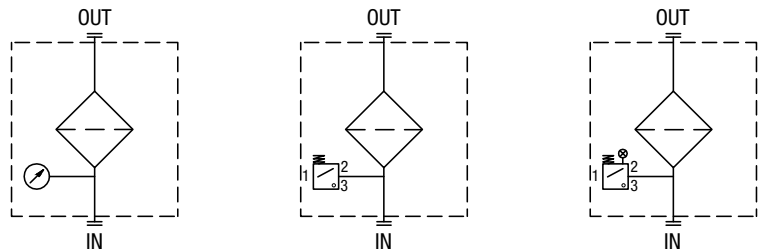

**D DIFFERENTIAL PRESSURE INDICATORS**

Differential pressure indicators are used on the Pressure line to check the efficiency of the filter element.

They measure the pressure upstream and downstream of the filter element (differential pressure).

Standard items are produced with special connection G 1/2" size.

Also available in Stainless Steel models. Differential pressure indicators are identified in the Hydraulic Filtration catalogue and in the Quick Reference Guide table by the letter "D".

Example:

**D** DVA20xP01

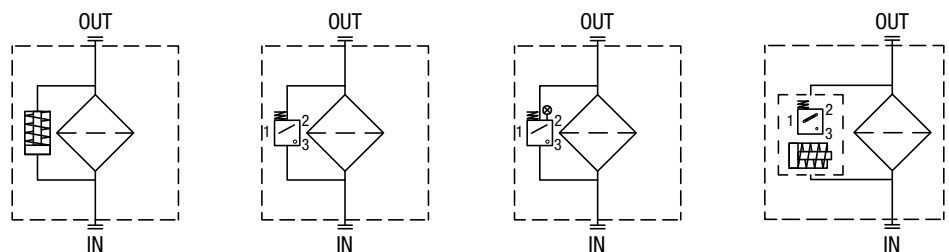

## FILTERS FOR POTENTIALLY EXPLOSIVE ATMOSPHERE

Designation & Ordering code

### DIFFERENTIAL PRESSURE INDICATORS

Series	Configuration example 1:						
<b>DE</b> Electrical differential pressure indicator	DE	H	50	F	A	48	P01
<b>DV</b> Visual differential pressure indicator	Configuration example 2:						
	DV	X	70	V			P01

Type	DE	DV
<b>A</b> With automatic reset	-	•
<b>M</b> With manual reset	-	•
<b>H</b> Stainless steel hazardous area 420 bar	•	-
<b>X</b> Stainless steel standard type 420 bar	-	•
<b>Y</b> Stainless steel optional type 420 bar	-	•

Pressure setting	DEH	DV
<b>12</b> 1.2 bar	-	•
<b>20</b> 2.0 bar	•	•
<b>50</b> 5.0 bar	•	•
<b>70</b> 7.0 bar	•	•
<b>95</b> 9.5 bar	-	•

Seals	DEH	DV
<b>H</b> HNBR	-	•
<b>V</b> FPM	•	•
<b>F</b> MFQ	•	-

Thermostat	DEH
<b>A</b> Without thermostat	•

Electrical connections	DEH
<b>48</b> Connection via three-core cable - fitting M20x1.5	•
<b>49</b> Connection via four-core cable - fitting 1/2" NPT	•
<b>70</b> Connection IEC 61076-2-101 D (M12)	•

Option
<b>P01</b> MP Filtri standard
<b>Pxx</b> Customized

### PLUGS

Series	Configuration example
<b>T2</b> Plug	X2 H
<b>X2</b> Stainless Steel plug 420 bar	
<b>X3</b> Stainless Steel plug 700 bar (only for FZH)	

Seals
<b>H</b> HNBR
<b>V</b> FPM
<b>F</b> MFQ

# VACUUM INDICATORS

## Technical data

VE*50 (EX)	
<b>Electrical Vacuum Indicator</b> Connection: EN 175301-803	
R	Ordering code
EN 10226 - R1/4"	VE A 21 x A 50 P01 VE A 21 x A 50 P01 EX
EN 10226 - R1/8"	VE B 21 A A 50 P01 VE B 21 A A 50 P01 EX

**Hydraulic symbol**

**Electrical symbol**

- Certification: ATEX, IECEx
- Certification included in EX version

**Materials**

- Body: Brass
- Base: Black polyamide
- Contacts: Silver
- Seal: VEA: NBR/FPM  
VEB: NBR

**Technical data**

- Vacuum setting: 0.21 bar ±10%
- Max working pressure: 10 bar
- Proof pressure: 15 bar
- Working temperature: From -25 °C to +80 °C
- Compatibility with fluids: Mineral oils, Synthetic fluids  
HFB and HFC according to ISO 2943
- Degree of protection: IP65 according to EN 60529

**Electrical data**

- Electrical connection: EN 175301-803
- Resistive load: 5 A / 14 Vdc  
4 A / 30 Vdc  
5 A / 125 Vac  
4 A / 250 Vac
- CE certification
- Available Atex product: II 1GD Ex ia IIC Tx Ex ia IIIC Tx °C X

VEA50 UL	
<b>Electrical Vacuum Indicator</b> Connection: EN 175301-803	
R	Ordering code
EN 10226 - R1/4"	VE A 21 A A 50 P01 UL

**Hydraulic symbol**

**Electrical symbol**

- Certification: UL
- Certification included in EX version

**Materials**

- Body: Brass
- Base: Black polyamide
- Contacts: Silver
- Seal: VEA: NBR/FPM  
VEB: NBR

**Technical data**

- Vacuum setting: 0.21 bar ±10%
- Max working pressure: 10 bar
- Proof pressure: 15 bar
- Working temperature: From -25 °C to +80 °C
- Compatibility with fluids: Mineral oils, Synthetic fluids  
HFB and HFC according to ISO 2943
- Degree of protection: IP65 according to EN 60529

**Electrical data**

- Electrical connection: EN 175301-803
- Resistive load: 5 A / 14 Vdc  
4 A / 30 Vdc  
5 A / 125 Vac  
4 A / 250 Vac
- CE certification
- Available Atex product: II 1GD Ex ia IIC Tx Ex ia IIIC Tx °C X

VL*51 - VL*52 - VL*53	
<b>Electrical/Visual Vacuum Indicator</b> Connection: EN 175301-803	
<b>51:</b> Transparent base with lamps 24 Vdc <b>52:</b> Transparent base with lamps 110 Vdc <b>53:</b> Transparent base with lamps 230 Vac	
R	Ordering code
EN 10226 - R1/4"	VL A 21 x A xx P01
EN 10226 - R1/8"	VL B 21 A A xx P01

**Hydraulic symbol**

**Electrical symbol**

**Materials**

- Body: Brass
- Base: Transparent polyamide
- Contacts: Brass - Polyamide
- Seal: VLA: NBR/FPM  
VLB: NBR



**Technical data**

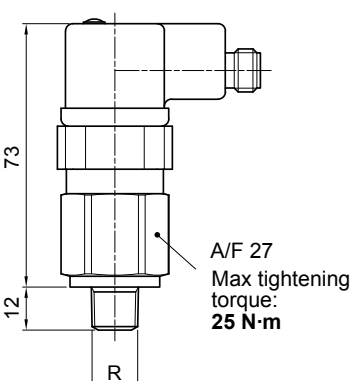
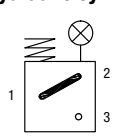
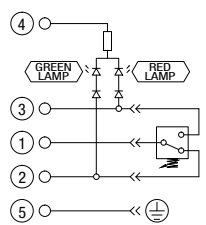

- Vacuum setting: 0.21 bar ±10%
- Max working pressure: 10 bar
- Proof pressure: 15 bar
- Working temperature: From -25 °C to +80 °C
- Compatibility with fluids: Mineral oils, Synthetic fluids  
HFB and HFC according to ISO 2943
- Degree of protection: IP65 according to EN 60529

**Electrical data**

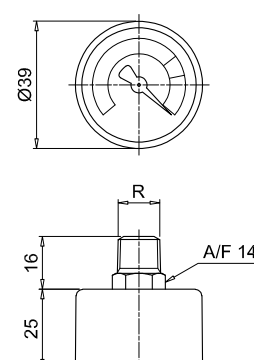
- Electrical connection: EN 175301-803
- Type: 51                      52                      53
- Lamps: 24 Vdc              110 Vdc              230 Vac
- Resistive load: 1 A / 24 Vdc    1 A / 110 Vdc    1 A / 230 Vac

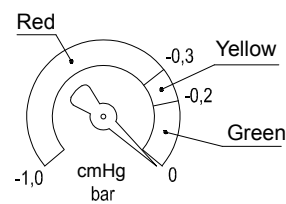
VL*71	
<b>Electrical/Visual Vacuum Indicator</b> Connection IEC 61076-2-101 D (M12), black base with lamps 24 Vdc	
Connections	Indicator code
EN 10226 - R1/4"	VL A 21 x A 71 P01
EN 10226 - R1/8"	VL B 21 A A 71 P01
	
<p><b>Hydraulic symbol</b></p>  <p><b>Electrical symbol</b></p> 	
<p><b>Materials</b></p> <ul style="list-style-type: none"> <li>- Body: Brass</li> <li>- Base: Black polyamide</li> <li>- Contacts: Silver</li> <li>- Seal: VLA: NBR/FPM VLB: NBR</li> </ul>	
<p><b>Technical data</b></p> <ul style="list-style-type: none"> <li>- Vacuum setting: 0.21 bar ±10%</li> <li>- Max working pressure: 10 bar</li> <li>- Proof pressure: 15 bar</li> <li>- Working temperature: From -25 °C to +80 °C</li> <li>- Compatibility with fluids: Mineral oils, Synthetic fluids HFB and HFC according to ISO 2943</li> <li>- Degree of protection: IP65 according to EN 60529</li> </ul>	
<p><b>Electrical data</b></p> <ul style="list-style-type: none"> <li>- Electrical connection: IEC 61076-2-101 D (M12)</li> <li>- Lamps: 24 Vdc (black base)</li> <li>- Resistive load: 0.4 A / 24 Vdc</li> </ul>	

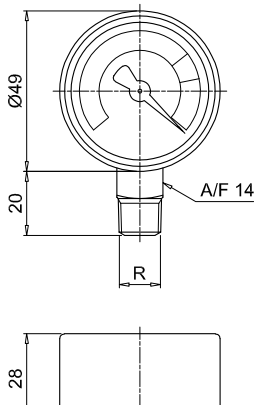
VVA - VVB									
<b>Axial Vacuum Gauge</b>									
R	Ordering code								
EN 10226 - R1/4"	VVA 20 P01								
EN 10226 - R1/8"	VVB 20 P01								
									
<p><b>Hydraulic symbol</b></p>  <p><b>Dial scale</b></p>  <p><b>Conversion to SI units</b></p> <table border="1" style="margin-left: auto; margin-right: auto;"> <thead> <tr> <th>[cmHg]</th> <th>[bar]</th> </tr> </thead> <tbody> <tr> <td>-12</td> <td>-0.16</td> </tr> <tr> <td>-18</td> <td>-0.24</td> </tr> <tr> <td>-76</td> <td>-1.01</td> </tr> </tbody> </table>		[cmHg]	[bar]	-12	-0.16	-18	-0.24	-76	-1.01
[cmHg]	[bar]								
-12	-0.16								
-18	-0.24								
-76	-1.01								
<p><b>Materials</b></p> <ul style="list-style-type: none"> <li>- Case: Black plastic</li> <li>- Window: Clear plastic</li> <li>- Dial: White plastic</li> <li>- Pointer: Black plastic</li> <li>- Pressure connection: Cu-alloy</li> <li>- Pressure element: Bourdon tube Cu-alloy soft soldered, C type</li> <li>- Movement: Cu-alloy</li> </ul>									
<p><b>Technical data</b></p> <ul style="list-style-type: none"> <li>- Max working pressure: Steady: -0.7 bar Fluctuating: -0.6 bar Short time: -1.0 bar</li> <li>- Working temperature: Ambienti from -40 °C to +60 °C Fluid max + 60 °C Storage from -40 °C to +60 °C</li> <li>- Compatibility with fluids: Mineral oils, Synthetic fluids HFB and HFC according to ISO 2943</li> <li>- Accuracy: Class 2.5 according to EN 13190</li> <li>- Degree of protection: IP31 according to EN 60529</li> </ul>									

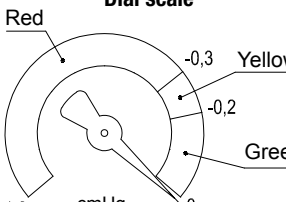
VVR - VVS										
<b>Radial Vacuum Gauge</b>										
R	A/F	Ordering code								
EN 10226 - R1/4"	14	VVR 20 P01								
EN 10226 - R1/8"	11	VVS 20 P01								
										
<p><b>Hydraulic symbol</b></p>  <p><b>Dial scale</b></p>  <p><b>Conversion to SI units</b></p> <table border="1" style="margin-left: auto; margin-right: auto;"> <thead> <tr> <th>[cmHg]</th> <th>[bar]</th> </tr> </thead> <tbody> <tr> <td>-12</td> <td>-0.16</td> </tr> <tr> <td>-18</td> <td>-0.24</td> </tr> <tr> <td>-76</td> <td>-1.01</td> </tr> </tbody> </table>			[cmHg]	[bar]	-12	-0.16	-18	-0.24	-76	-1.01
[cmHg]	[bar]									
-12	-0.16									
-18	-0.24									
-76	-1.01									
<p><b>Materials</b></p> <ul style="list-style-type: none"> <li>- Case: Black plastic</li> <li>- Window: Clear plastic</li> <li>- Dial: White plastic</li> <li>- Pointer: Black plastic</li> <li>- Pressure connection: Cu-alloy</li> <li>- Pressure element: Bourdon tube Cu-alloy soft soldered, C type</li> <li>- Movement: Cu-alloy</li> </ul>										
<p><b>Technical data</b></p> <ul style="list-style-type: none"> <li>- Max working pressure: Steady: -0.7 bar Fluctuating: -0.6 bar Short time: -1.0 bar</li> <li>- Working temperature: Ambienti from -40 °C to +60 °C Fluid max + 60 °C Storage from -40 °C to +60 °C</li> <li>- Compatibility with fluids: Mineral oils, Synthetic fluids HFB and HFC according to ISO 2943</li> <li>- Accuracy: Class 2.5 according to EN 13190</li> <li>- Degree of protection: IP31 according to EN 60529</li> </ul>										

# BAROMETRIC (PRESSURE) INDICATORS

## Dimensions

BEA*50 (EX)	
<b>Electrical Pressure Indicator</b> Connection EN 175301-803	
Settings	Ordering code
1.5 bar ±10%	BE A 15 HA 50 P01 BE A 15 HA 50 P01 EX
2.0 bar ±10%	BE A 20 HA 50 P01 BE A 20 HA 50 P01 EX

A/F 27  
Max tightening torque: **25 N·m**

EN 10226 - R1/8"

**Hydraulic symbol**

**Electrical symbol**

- Certification: ATEX, IECEx
- Certification included in EX version

**Materials**

- Body: Brass
- Base: Black polyamide
- Contacts: Silver
- Seal: HNBR

**Technical data**

- Max working pressure: 40 bar
- Proof pressure: 60 bar
- Working temperature: From -25 °C to +80 °C
- Compatibility with fluids: Mineral oils, Synthetic fluids  
HFB and HFC according to ISO 2943
- Degree of protection: IP65 according to EN 60529

**Electrical data**

- Electrical connection: EN 175301-803
- Resistive load:
  - 5 A / 14 Vdc
  - 4 A / 30 Vdc
  - 5 A / 125 Vac
  - 4 A / 250 Vac
- CE certification
- Available Atex product: I M1 Ex ia I Ma  
II 1GD Ex ia IIC Tx Ex ia IIIC Tx °C X

BEA*50 UL	
<b>Electrical Pressure Indicator</b> Connection EN 175301-803	
Settings	Ordering code
1.5 bar ±10%	BE A 15 HA 50 P01 UL
2.0 bar ±10%	BE A 20 HA 50 P01 UL

A/F 27  
Max tightening torque: **25 N·m**

EN 10226 - R1/8"

**Hydraulic symbol**

**Electrical symbol**

- Certification: UL
- Certification included in EX version

**Materials**

- Body: Brass
- Base: Black polyamide
- Contacts: Silver
- Seal: HNBR

**Technical data**

- Max working pressure: 40 bar
- Proof pressure: 60 bar
- Working temperature: From -25 °C to +80 °C
- Compatibility with fluids: Mineral oils, Synthetic fluids  
HFB and HFC according to ISO 2943
- Degree of protection: IP65 according to EN 60529

**Electrical data**

- Electrical connection: EN 175301-803
- Resistive load:
  - 5 A / 14 Vdc
  - 4 A / 30 Vdc
  - 5 A / 125 Vac
  - 4 A / 250 Vac
- CE certification
- Available Atex product: I M1 Ex ia I Ma  
II 1GD Ex ia IIC Tx Ex ia IIIC Tx °C X

BEM*41	
<b>Electrical Pressure Indicator</b> Connection via four-core cable	
Settings	Ordering code
1.5 bar ±10%	BE M 15 HA 41 P01
2.0 bar ±10%	BE M 20 HA 41 P01

A/F 27  
Max tightening torque: **25 N·m**

EN 10226 - R1/8"

**Hydraulic symbol**

**Electrical symbol**

**Materials**

- Body: Brass
- Base: Black polyamide
- Contacts: Silver
- Seal: HNBR

**Technical data**

- Max working pressure: 40 bar
- Proof pressure: 60 bar
- Working temperature: From -25 °C to +80 °C
- Compatibility with fluids: Mineral oils, Synthetic fluids  
HFB and HFC according to ISO 2943
- Degree of protection: IP67 according to EN 60529

**Electrical data**

- Electrical connection: Four-core cable
- Resistive load:
  - 5 A / 14 Vdc
  - 4 A / 30 Vdc
  - 5 A / 125 Vac
  - 4 A / 250 Vac
- CE certification
- On request this indicator can be provided with main connectors in use for wirings.

BET*F10	
<b>Electrical Pressure Indicator</b> Connection AMP Superseal series 1.5	
Settings	Ordering code
2.0 bar $\pm 10\%$	BET 20 H F 10 P01
2.5 bar $\pm 10\%$	BET 25 H F 10 P01

**Hydraulic symbol**

**Electrical symbol**

**Materials**

- Body: Brass
- Base: Black polyamide
- Contacts: Silver
- Seal: HNBR

**Technical data**

- Max working pressure: 10 bar
- Proof pressure: 15 bar
- Working temperature: From -25 °C to +100 °C
- Compatibility with fluids: Mineral oils, Synthetic fluids HFB and HFC according to ISO 2943
- Degree of protection: IP65 according to EN 60529

**Electrical data**

- Electrical connection: AMP Superseal series 1.5
- Resistive load: 0.5 A / 48 Vdc
- Thermostat condition: Open up to 30 °C
- CE certification

BET*F30	
<b>Electrical Pressure Indicator</b> Deutsch DT-04-2-P	
Settings	Ordering code
2.0 bar $\pm 10\%$	BET 20 H F 30 P01
2.5 bar $\pm 10\%$	BET 25 H F 30 P01

**Hydraulic symbol**

**Electrical symbol**

**Materials**

- Body: Brass
- Base: Black polyamide
- Contacts: Silver
- Seal: HNBR

**Technical data**

- Max working pressure: 10 bar
- Proof pressure: 15 bar
- Working temperature: From -25 °C to +100 °C
- Compatibility with fluids: Mineral oils, Synthetic fluids HFB and HFC according to ISO 2943
- Degree of protection: IP65 according to EN 60529

**Electrical data**

- Electrical connection: Deutsch DT-04-2-P
- Resistive load: 0.5 A / 48 Vdc
- Thermostat condition: Open up to 30 °C
- CE certification

BET*F50	
<b>Electrical Pressure Indicator</b> Connection EN 175301-803	
Settings	Ordering code
2.0 bar $\pm 10\%$	BET 20 H F 50 P01
2.5 bar $\pm 10\%$	BET 25 H F 50 P01

**Hydraulic symbol**

**Electrical symbol**

**Materials**

- Body: Brass
- Base: Black polyamide
- Contacts: Silver
- Seal: HNBR

**Technical data**

- Max working pressure: 10 bar
- Proof pressure: 15 bar
- Working temperature: From -25 °C to +100 °C
- Compatibility with fluids: Mineral oils, Synthetic fluids HFB and HFC according to ISO 2943
- Degree of protection: IP65 according to EN 60529

**Electrical data**

- Electrical connection: EN 175301-803
- Resistive load: 0.5 A / 48 Vdc
- Thermostat condition: Open up to 30 °C
- CE certification



# BAROMETRIC (PRESSURE) INDICATORS

## Dimensions

BL*51 - BL*52 - BL*53	
<b>Electrical/Visual Pressure Indicator</b> Connection: EN 175301-803	
51: Transparent base with lamps 24 Vdc 52: Transparent base with lamps 110 Vdc 53: Transparent base with lamps 230 Vac	
Settings	Ordering code
1.5 bar ±10%	BL A 15 H A xx P01
2.0 bar ±10%	BL A 20 H A xx P01
<b>Hydraulic symbol</b> 	
<b>Electrical symbol</b> 	
<b>Materials</b> - Body: Brass - Base: Transparent polyamide - Contacts: Silver - Seal: HNBR	
<b>Technical data</b> - Max working pressure: 40 bar - Proof pressure: 60 bar - Working temperature: From -25 °C to +80 °C - Compatibility with fluids: Mineral oils, Synthetic fluids HFB and HFC according to ISO 2943 - Degree of protection: IP65 according to EN 60529	
<b>Electrical data</b> - Electrical connection: EN 175301-803 - Type: 51                      52                      53 - Lamps: 24 Vdc              110 Vdc              230 Vac - Resistive load: 1 A / 24 Vdc    1 A / 110 Vdc    1 A / 230 Vac	

BL*71	
<b>Electrical/Visual Pressure Indicator</b> Connection IEC 61076-2-101 D (M12), black base with lamps 24 Vdc	
Settings	Ordering code
1.5 bar ±10%	BL A 15 H A 71 P01
2.0 bar ±10%	BL A 20 H A 71 P01
<b>Hydraulic symbol</b> 	
<b>Electrical symbol</b> 	
<b>Materials</b> - Body: Brass - Base: Black polyamide - Contacts: Silver - Seal: HNBR	
<b>Technical data</b> - Max working pressure: 40 bar - Proof pressure: 60 bar - Working temperature: From -25 °C to +80 °C - Compatibility with fluids: Mineral oils, Synthetic fluids HFB and HFC according to ISO 2943 - Degree of protection: IP65 according to EN 60529	
<b>Electrical data</b> - Electrical connection: IEC 61076-2-101 D (M12) - Lamps: 24 Vdc (black base) - Resistive load: 0.4 A / 24 Vdc	

BVA	
<b>Axial Pressure Gauge</b>	
Settings	Ordering code
1.4 bar ±10%	BV A 14 P01
2.5 bar ±10%	BV A 25 P01
<b>Hydraulic symbol</b> 	
<b>Dial scale</b> BV A 14 P01 	
BV A 25 P01 	
<b>Materials</b> - Case: Painted Steel - Window: Clear plastic - Dial: Painted Steel - Pointer: Black plastic - Pressure connection: Brass - Pressure element: Bourdon tube Cu-alloy soft soldered, C type	
<b>Technical data</b> - Max working pressure: Static: 7 bar Fluctuating: 6 bar Short time: 10 bar - Working temperature: Ambient from -40 °C to +60 °C Fluid max +60 °C - Compatibility with fluids: Mineral oils, Synthetic fluids HFB and HFC according to ISO 2943 - Accuracy: Class 2.5 according to EN 13190 - Degree of protection: IP31 according to EN 60529	

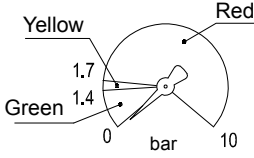
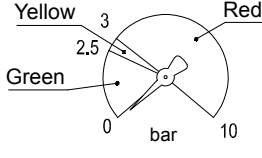
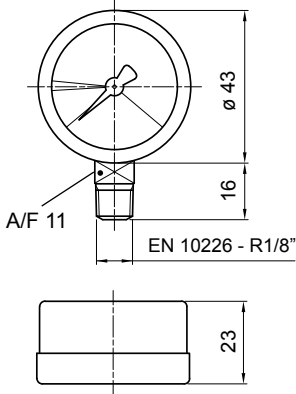
BVR		Hydraulic symbol	Materials
<b>Radial Pressure Gauge</b>			
Settings	Ordering code		
1.4 bar ±10%	BV R 14 P01	<b>Dial scale</b> BV R 14 P01 	
2.5 bar ±10%	BV R 25 P01		BV R 25 P01 
			
		<b>Technical data</b> <ul style="list-style-type: none"> <li>- Max working pressure: Static: 7 bar Fluctuating: 6 bar Short time: 10 bar</li> <li>- Working temperature: Ambient from -40 °C to +60 °C Fluid max +60 °C</li> <li>- Compatibility with fluids: Mineral oils, Synthetic fluids HFB and HFC according to ISO 2943</li> <li>- Accuracy: Class 2.5 according to EN 13190</li> <li>- Degree of protection: IP31 according to EN 60529</li> </ul>	

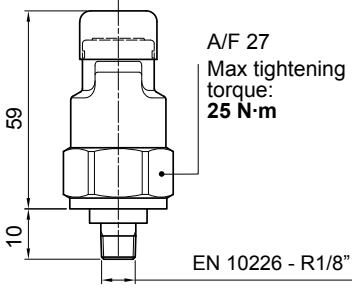
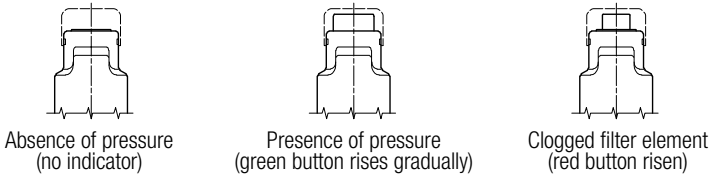
BVP - BVQ		Hydraulic symbol	Materials
<b>Visual Pressure Indicator</b>			
Setting	Ordering code		
1.5 bar ±10%	BV P 15 H P01		<b>Technical data</b> <ul style="list-style-type: none"> <li>- Reset: BVP - Automatic reset BVQ - Manual reset</li> <li>- Max working pressure: 10 bar</li> <li>- Proof pressure: 15 bar</li> <li>- Working temperature: From -25 °C to +80 °C</li> <li>- Compatibility with fluids: Mineral oils, Synthetic fluids HFB and HFC according to ISO 2943</li> <li>- Degree of protection: IP45 according to EN 60529</li> </ul>
	BV Q 15 H P01		
2.0 bar ±10%	BV P 20 H P01		
	BV Q 20 H P01		
			
		<b>Signals</b> 	

# DIFFERENTIAL PRESSURE INDICATORS

## Dimensions

DEA*50	
<b>Electrical Differential Pressure Indicator</b> Connection: EN 175301-803	
Settings	Ordering code
1.2 bar ±10%	DE A 12 x A 50 P01
2.0 bar ±10%	DE A 20 x A 50 P01
5.0 bar ±10%	DE A 50 x A 50 P01
7.0 bar ±10%	DE A 70 x A 50 P01
9.5 bar ±10%	DE A 95 x A 50 P01

A/F 30  
Max tightening torque: **65 N·m**

**Hydraulic symbol**

**Electrical symbol**

**Materials**

- Body: Brass
- Base: Black polyamide
- Contacts: Silver
- Seal: HNBR - FPM

**Technical data**

- Max working pressure: 420 bar
- Proof pressure: 630 bar
- Burst pressure: 1260 bar
- Working temperature: From -25 °C to +110 °C
- Compatibility with fluids: Mineral oils, Synthetic fluids  
HFB and HFC according to ISO 2943
- Degree protection: IP66 according to EN 60529  
IP69K according to ISO 20653

**Electrical data**

- Electrical connection: EN 175301-803
- Resistive load: 0.2 A / 115 Vdc

DEH*48	
<b>Hazardous Area Electrical Differential Pressure Indicator</b> Connection via three-core cable - fitting M20x1.5	
Settings	Ordering code
2.0 bar ±10%	DE H 20 x A 48 P01
5.0 bar ±10%	DE H 50 x A 48 P01
7.0 bar ±10%	DE H 70 x A 48 P01

A/F 25  
Max tightening torque: **100 N·m**

M20 x 1.5

min. 110

88

flexible cable ≈ 5000 to A

**Hydraulic symbol**

**Electrical symbol**

**Materials**

- Body: AISI 316L
- Contacts: Rhodium
- Seal: FPM - MFQ

**Technical data**

- Max working pressure: 420 bar
- Proof pressure: 630 bar
- Burst pressure: 1260 bar
- Working temperature: From -60 °C to +125 °C
- Compatibility with fluids: Mineral oils, Synthetic fluids  
HFB and HFC according to ISO 2943
- Temperature class: T4 (135 °C) and T6 (85 °C)
- Degree of protection: IP 66/67/68 according to EN 60529
- Connection type: Three-core cable, fitting M20x1.5
- Contact type: SPCO/SPDT (Hermetically sealed - Volt-free contacts)

**Electrical data**

- Connection via three-core cable - fitting M20x1.5
- Resistive Load: 830 mA / 24 Vdc - 180 mA / 110 Vac
- Electrical Ratings:  $U_i = 30 \text{ Vdc} / I_i = 250 \text{ mA} / P_i = 1.3 \text{ W}$
- Available ATEX product: II 1 GD Ex ia IIC T6 Ga -60°C ≤ Ta ≤ 80°C  
Ex ia IIC T4 Ga -60°C ≤ Ta ≤ 125°C  
II 2 GD Ex db IIC T6\* Gb Ex tb IIIC T85°C\* Db  
(Tamb : = -60°C to +70°C)\* IP66/67  
\* alternative T/Class and ambients T4, T135°C  
(Tamb = -60°C to +120°C)

**Certification / Approvals:**  
ATEX, IECEx, EAC TR CU, INMETRO  
- Certification included as standard

DEH*49	
<b>Hazardous Area Electrical Differential Pressure Indicator</b> Connection via four-core cable - fitting 1/2" NPT	
Settings	Ordering code
2.0 bar ±10%	DE H 20 x A 49 P01
5.0 bar ±10%	DE H 50 x A 49 P01
7.0 bar ±10%	DE H 70 x A 49 P01

A/F 25  
Max tightening torque: **100 N·m**

1/2" NPT

min. 110

88

flexible cable ≈ 5000 to A

**Hydraulic symbol**

**Electrical symbol**

**Materials**

- Body: AISI 316L
- Contacts: Rhodium
- Seal: FPM - MFQ

**Technical data**

- Max working pressure: 420 bar
- Proof pressure: 630 bar
- Burst pressure: 1260 bar
- Working temperature: From -60 °C to +120 °C : ATEX, IECEx, EAC TR CU, INMETRO  
From -60 °C to +105 °C : UL/CSA
- Compatibility with fluids: Mineral oils, Synthetic fluids  
HFB and HFC according to ISO 2943
- Temperature class: T4 (135 °C) and T6 (85 °C)
- Degree of protection: IP 66/67/68 according to EN 60529
- Connection type: Four-core cable, fitting 1/2" NPT
- Contact type: SPCO/SPDT (Hermetically sealed - Volt-free contacts)

**Electrical data**

- Connection via four-core cable - fitting 1/2" NPT
- Resistive Load: 830 mA / 24 Vdc - 180 mA / 110 Vac
- Max voltage: 150 Vac/dc
- Power: 20 W
- Available ATEX product: II 1 GD Ex ia IIC T6 Ga -60°C ≤ Ta ≤ 80°C  
Ex ia IIC T4 Ga -60°C ≤ Ta ≤ 125°C  
II 2 GD Ex db IIC T6\* Gb Ex tb IIIC T85°C\* Db  
(Tamb : = -60°C to +70°C)\* IP66/67  
\* alternative T/Class and ambients T4, T135°C  
(Tamb = -60°C to +120°C)

**Certification / Approvals:**  
ATEX, IECEx, EAC TR CU, INMETRO, UL/CSA Class I Division 1 Groups A-D, UL/CSA Class II Division 1 Groups E-G  
- Certification included as standard

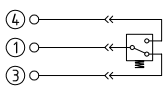
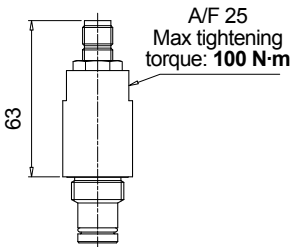
DEH*70		Hydraulic symbol	<b>Materials</b> - Body: AISI 316L with internal engineered resin switch - Contacts: Rhodium - Seal: FPM - MFQ
<b>Hazardous Area</b> <b>Electrical Differential Pressure Indicator</b> Connection IEC 61076-2-101 D (M12)			
Settings	Ordering code	Electrical symbol	<b>Technical data</b> - Max working pressure: 420 bar - Proof pressure: 630 bar - Burst pressure: 1260 bar - Working temperature: From -60 °C to +80 °C - Compatibility with fluids: Mineral oils, Synthetic fluids HFB and HFC according to ISO 2943 - Temperature class: T6 (85 °C) - Degree of protection: IP 66/67 according to EN 60529 - Connection type: IEC 61076-2-101 D (M12) - Contact type: SPCO/SPDT (Hermetically sealed - Volt-free contacts)
2.0 bar ±10%	DE H 20 x A 70 P01		
5.0 bar ±10%	DE H 50 x A 70 P01		<b>Electrical data</b> - Connection IEC 61076-2-101 D (M12) - Resistive Load: 830 mA / 24 Vdc - 180 mA / 110 Vdc - Electrical Ratings: <i>I</i> <sub>i</sub> = 30 Vdc <i>I</i> <sub>l</sub> = 250 mA <i>P</i> <sub>i</sub> = 1.3 W - Available ATEX product: II 1 GD Ex ia IIC T6 Ga -60°C ≤ Ta ≤ 80°C Ex ia IIC T4 Ga -60°C ≤ Ta ≤ 125°C II 2 GD Ex db IIC T6* Gb Ex tb IIIC T85°C* Db (Tamb = -60°C to +70°C)* IP66/67 * alternative T/Class and ambients T4, T135°C (Tamb = -60°C to +120°C)
7.0 bar ±10%	DE H 70 x A 70 P01		
		- Certification / Approvals: ATEX, IECEx, EAC TR CU, INMETRO - Certification included as standard	

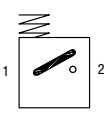
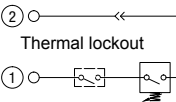
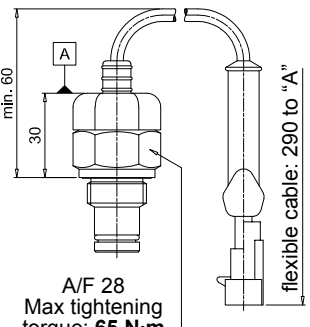
DEM*F10		Hydraulic symbol	<b>Materials</b> - Body: Brass - Base: Black polyamide - Contacts: Silver - Seal: HNBR - FPM
<b>Electrical Differential Pressure Indicator</b> Connection: AMP Superseal series 1.5			
Settings	Ordering code	Electrical symbol	<b>Technical data</b> - Max working pressure: 420 bar - Proof pressure: 630 bar - Burst pressure: 1260 bar - Working temperature: From -25 °C to +110 °C - Compatibility with fluids: Mineral oils, Synthetic fluids HFB and HFC according to ISO 2943 - Degree protection: IP66 according to EN 60529
1.2 bar ±10%	DE M 12 x F 10 P01		
2.0 bar ±10%	DE M 20 x F 10 P01		<b>Electrical data</b> - Electrical connection: AMP Superseal series 1.5 - Resistive load: 0.2 A / 115 Vdc - Switching type: Normally open contacts (NC on request) - Thermal lockout: Normally open up to 30 °C (option "F")
5.0 bar ±10%	DE M 50 x F 10 P01		
7.0 bar ±10%	DE M 70 x F 10 P01	- Certification / Approvals: ATEX, IECEx, EAC TR CU, INMETRO - Certification included as standard	
9.5 bar ±10%	DE M 95 x F 10 P01		

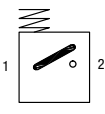
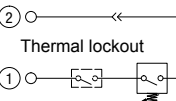
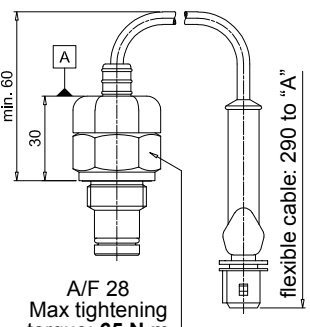
DEM*F20		Hydraulic symbol	<b>Materials</b> - Body: Brass - Base: Black polyamide - Contacts: Silver - Seal: HNBR - FPM
<b>Electrical Differential Pressure Indicator</b> AMP Time junior			
Settings	Ordering code	Electrical symbol	<b>Technical data</b> - Max working pressure: 420 bar - Proof pressure: 630 bar - Burst pressure: 1260 bar - Working temperature: From -25 °C to +110 °C - Compatibility with fluids: Mineral oils, Synthetic fluids HFB and HFC according to ISO 2943 - Degree protection: IP66 according to EN 60529
1.2 bar ±10%	DE M 12 x F 20 P01		
2.0 bar ±10%	DE M 20 x F 20 P01		<b>Electrical data</b> - Electrical connection: AMP Time junior - Resistive load: 0.2 A / 115 Vdc - Switching type: Normally open contacts (NC on request) - Thermal lockout: Normally open up to 30 °C (option "F")
5.0 bar ±10%	DE M 50 x F 20 P01		
7.0 bar ±10%	DE M 70 x F 20 P01	- Certification / Approvals: ATEX, IECEx, EAC TR CU, INMETRO - Certification included as standard	
9.5 bar ±10%	DE M 95 x F 20 P01		

# DIFFERENTIAL PRESSURE INDICATORS

## Dimensions

DEM*F30	
<b>Electrical Differential Pressure Indicator</b> Deutsch DT-04-2-P	
Settings	Ordering code
1.2 bar ±10%	DE M 12 x F 30 P01
2.0 bar ±10%	DE M 20 x F 30 P01
5.0 bar ±10%	DE M 50 x F 30 P01
7.0 bar ±10%	DE M 70 x F 30 P01
9.5 bar ±10%	DE M 95 x F 30 P01

A/F 28  
Max tightening torque: 65 N·m

flexible cable: 240 to "A"

**Hydraulic symbol**

**Electrical symbol**

Thermal lockout

**Materials**

- Body: Brass
- Base: Black polyamide
- Contacts: Silver
- Seal: HNBR - FPM

**Technical data**

- Max working pressure: 420 bar
- Proof pressure: 630 bar
- Burst pressure: 1260 bar
- Working temperature: From -25 °C to +110 °C
- Compatibility with fluids: Mineral oils, Synthetic fluids  
HFB and HFC according to ISO 2943
- Degree protection: IP66 according to EN 60529

**Electrical data**

- Electrical connection: Deutsch DT-04-2-P
- Resistive load: 0.2 A / 115 Vdc
- Switching type: Normally open contacts (NC on request)
- Thermal lockout: Normally open up to 30 °C (option "F")

DEM*F35	
<b>Electrical Differential Pressure Indicator</b> Deutsch DT-04-3-P	
Settings	Ordering code
1.2 bar ±10%	DE M 12 x F 35 P01
2.0 bar ±10%	DE M 20 x F 35 P01
5.0 bar ±10%	DE M 50 x F 35 P01
7.0 bar ±10%	DE M 70 x F 35 P01
9.5 bar ±10%	DE M 95 x F 35 P01

A/F 28  
Max tightening torque: 65 N·m

flexible cable: 240 to "A"

**Hydraulic symbol**

**Electrical symbol**

Thermal lockout

**Materials**

- Body: Brass
- Base: Black polyamide
- Contacts: Silver
- Seal: HNBR - FPM

**Technical data**

- Max working pressure: 420 bar
- Proof pressure: 630 bar
- Burst pressure: 1260 bar
- Working temperature: From -25 °C to +110 °C
- Compatibility with fluids: Mineral oils, Synthetic fluids  
HFB and HFC according to ISO 2943
- Degree protection: IP66 according to EN 60529

**Electrical data**

- Electrical connection: Deutsch DT-04-3-P
- Resistive load: 0.2 A / 115 Vdc
- Switching type: SPDT contact
- Thermal lockout: Normally open up to 30 °C (option "F")

DEM*A10	
<b>Electrical Differential Pressure Indicator</b> Connection: AMP Superseal series 1.5	
Settings	Ordering code
1.2 bar ±10%	DE M 12 x A 10 P01
2.0 bar ±10%	DE M 20 x A 10 P01
5.0 bar ±10%	DE M 50 x A 10 P01
7.0 bar ±10%	DE M 70 x A 10 P01
9.5 bar ±10%	DE M 95 x A 10 P01

A/F 28  
Max tightening torque: 65 N·m

flexible cable: 290 to "A"

**Hydraulic symbol**

**Electrical symbol**

**Materials**

- Body: Brass
- Base: Black polyamide
- Contacts: Silver
- Seal: HNBR - FPM

**Technical data**

- Max working pressure: 420 bar
- Proof pressure: 630 bar
- Burst pressure: 1260 bar
- Working temperature: From -25 °C to +110 °C
- Compatibility with fluids: Mineral oils, Synthetic fluids  
HFB and HFC according to ISO 2943
- Degree protection: IP66 according to EN 60529

**Electrical data**

- Electrical connection: AMP Superseal series 1.5
- Resistive load: 0.2 A / 115 Vdc
- Switching type: Normally open contacts (NC on request)

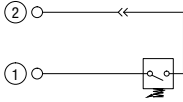
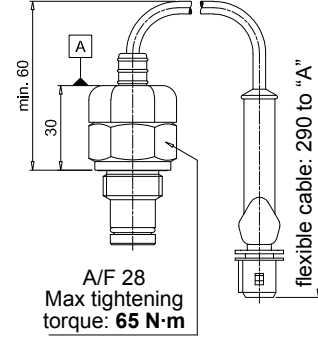
DEM*A20		Hydraulic symbol	Materials
<b>Electrical Differential Pressure Indicator</b> AMP Time junior			
Settings	Ordering code		
1.2 bar ±10%	DE M 12 x A 20 P01	<b>Electrical symbol</b> 	<b>Technical data</b> - Max working pressure: 420 bar - Proof pressure: 630 bar - Burst pressure: 1260 bar - Working temperature: From -25 °C to +110 °C - Compatibility with fluids: Mineral oils, Synthetic fluids HFB and HFC according to ISO 2943 - Degree protection: IP66 according to EN 60529
2.0 bar ±10%	DE M 20 x A 20 P01		
5.0 bar ±10%	DE M 50 x A 20 P01		
7.0 bar ±10%	DE M 70 x A 20 P01		
9.5 bar ±10%	DE M 95 x A 20 P01		
 <p>A/F 28 Max tightening torque: 65 N·m</p>		<b>Electrical data</b> - Electrical connection: AMP Time junior - Resistive load: 0.2 A / 115 Vdc - Switching type: Normally open contacts (NC on request)	

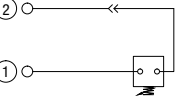
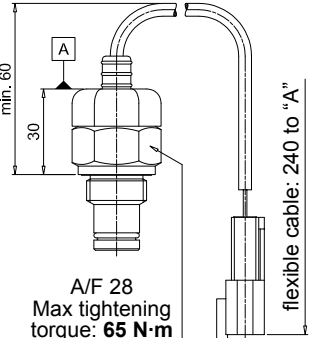
DEM*A30		Hydraulic symbol	Materials
<b>Electrical Differential Pressure Indicator</b> Deutsch DT-04-2-P			
Settings	Ordering code		
1.2 bar ±10%	DE M 12 x A 30 P01	<b>Electrical symbol</b> 	<b>Technical data</b> - Max working pressure: 420 bar - Proof pressure: 630 bar - Burst pressure: 1260 bar - Working temperature: From -25 °C to +110 °C - Compatibility with fluids: Mineral oils, Synthetic fluids HFB and HFC according to ISO 2943 - Degree protection: IP66 according to EN 60529
2.0 bar ±10%	DE M 20 x A 30 P01		
5.0 bar ±10%	DE M 50 x A 30 P01		
7.0 bar ±10%	DE M 70 x A 30 P01		
9.5 bar ±10%	DE M 95 x A 30 P01		
 <p>A/F 28 Max tightening torque: 65 N·m</p>		<b>Electrical data</b> - Electrical connection: Deutsch DT-04-2-P - Resistive load: 0.2 A / 115 Vdc - Switching type: Normally open contacts (NC on request)	

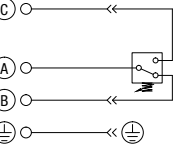
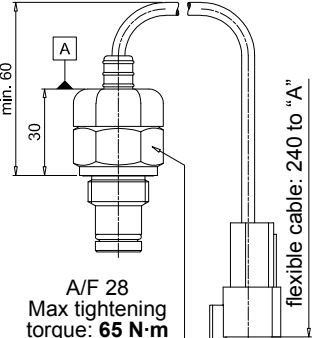
DEM*A35		Hydraulic symbol	Materials
<b>Electrical Differential Pressure Indicator</b> Deutsch DT-04-3-P			
Settings	Ordering code		
1.2 bar ±10%	DE M 12 x A 35 P01	<b>Electrical symbol</b> 	<b>Technical data</b> - Max working pressure: 420 bar - Proof pressure: 630 bar - Burst pressure: 1260 bar - Working temperature: From -25 °C to +110 °C - Compatibility with fluids: Mineral oils, Synthetic fluids HFB and HFC according to ISO 2943 - Degree protection: IP66 according to EN 60529
2.0 bar ±10%	DE M 20 x A 35 P01		
5.0 bar ±10%	DE M 50 x A 35 P01		
7.0 bar ±10%	DE M 70 x A 35 P01		
9.5 bar ±10%	DE M 95 x A 35 P01		
 <p>A/F 28 Max tightening torque: 65 N·m</p>		<b>Electrical data</b> - Electrical connection: Deutsch DT-04-3-P - Resistive load: 0.2 A / 115 Vdc - Switching type: SPDT contact	

# DIFFERENTIAL PRESSURE INDICATORS

## Dimensions

DES*10	
<b>Electrical Differential Pressure Indicator</b> AMP Superseal series 1.5	
Settings	Ordering code
1.2 bar $\pm 10\%$	DE S 12 H A 10 P01
2.5 bar $\pm 10\%$	DE S 25 H A 10 P01
4.0 bar $\pm 10\%$	DE S 40 H A 10 P01

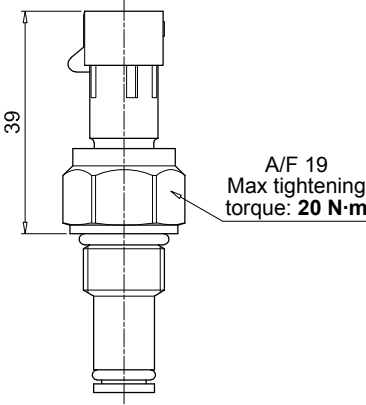

**Hydraulic symbol**

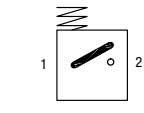

**Electrical symbol**

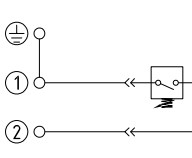

**Materials**

- Body: Brass
- Internal parts: Brass - Polyamide
- Contacts: Silver
- Seal: HNBR

**Technical data**

- Max working pressure: 16 bar
- Proof pressure: 24 bar
- Burst pressure: 48 bar
- Working temperature: From -25 °C to +110 °C
- Compatibility with fluids: Mineral oils, Synthetic fluids

- Degree protection: IP67 according to EN 60529

**Electrical data**

- Electrical connection: AMP Superseal series 1.5
- Resistive load: 0.2 A / 24 Vdc
- Switching type: Normally open contacts (NC on request)

DES*30	
<b>Electrical Differential Pressure Indicator</b> Deutsch DT-04-2-P	
Settings	Ordering code
1.2 bar $\pm 10\%$	DE S 12 H A 30 P01
2.5 bar $\pm 10\%$	DE S 25 H A 30 P01
4.0 bar $\pm 10\%$	DE S 40 H A 30 P01

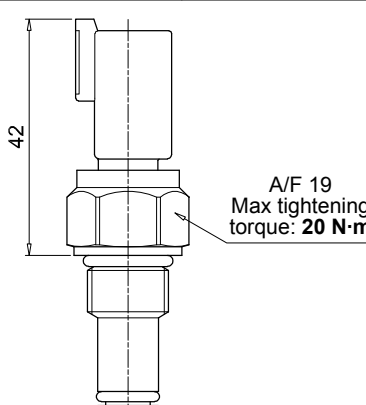

**Hydraulic symbol**

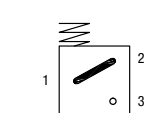

**Electrical symbol**

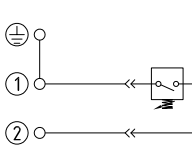

**Materials**

- Body: Brass
- Internal parts: Brass - Polyamide
- Contacts: Silver
- Seal: HNBR

**Technical data**

- Max working pressure: 16 bar
- Proof pressure: 24 bar
- Burst pressure: 48 bar
- Working temperature: From -25 °C to +110 °C
- Compatibility with fluids: Mineral oils, Synthetic fluids

- Degree protection: IP67 according to EN 60529

**Electrical data**

- Electrical connection: Deutsch DT-04-2-P
- Resistive load: 0.2 A / 24 Vdc
- Switching type: Normally open contacts (NC on request)

DES*80	
<b>Electrical Differential Pressure Indicator</b> Stud #10-32 UNF	
Settings	Ordering code
1.2 bar $\pm 10\%$	DE S 12 H A 80 P01
2.5 bar $\pm 10\%$	DE S 25 H A 80 P01
4.0 bar $\pm 10\%$	DE S 40 H A 80 P01

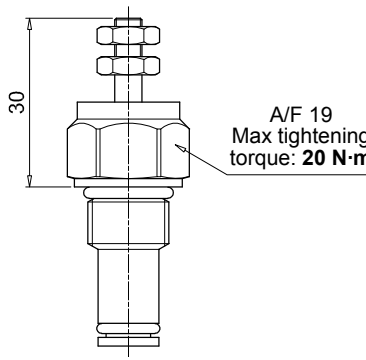

**Hydraulic symbol**

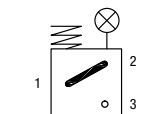

**Electrical symbol**

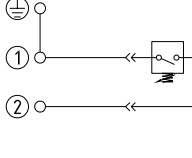

**Materials**

- Body: Brass
- Internal parts: Brass - Polyamide
- Contacts: Silver
- Seal: HNBR

**Technical data**

- Max working pressure: 16 bar
- Proof pressure: 24 bar
- Burst pressure: 48 bar
- Working temperature: From -25 °C to +110 °C
- Compatibility with fluids: Mineral oils, Synthetic fluids

- Degree protection: IP67 according to EN 60529

**Electrical data**

- Electrical connection: Stud #10-32 UNF
- Resistive load: 0.2 A / 24 Vdc
- Switching type: Normally open contacts (NC on request)



DEU*50 UL	
<b>Electrical Differential Pressure Indicator</b> Connection EN 175301-803	
Settings	Ordering code
2.0 bar ±10%	DE U 20 H A 50 P01 UL
5.0 bar ±10%	DE U 50 H A 50 P01 UL
7.0 bar ±10%	DE U 70 H A 50 P01 UL

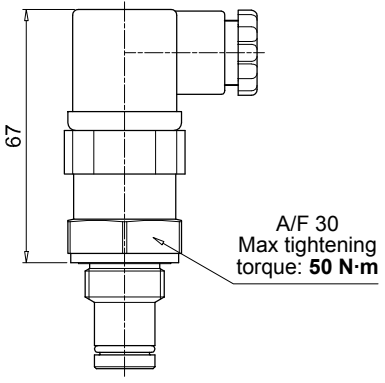

**Hydraulic symbol**

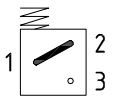

**Electrical symbol**

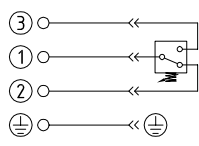

**Materials**

- Body: Brass
- Base: Black Polyamide
- Contacts: Silver
- Seal: HNBR

**Technical data**

- Max working pressure: 210 bar
- Proof pressure: 220 bar
- Burst pressure: 880 bar
- Working temperature: From -25 °C to +85 °C
- Compatibility with fluids: Mineral oils, Synthetic fluids  
HFB and HFC according to ISO 2943
- Degree protection: IP65 according to EN 60529

**Electrical data**

- Electrical connection: EN 175301-803
- Resistive load: 3 A / 30 Vdc  
3 A / 125 Vac  
3 (3) A / 250 Vac

**UL**

- Certification: UL
- Certification included in EX version

DEX*50	
<b>Electrical Differential Pressure Indicator</b> Connection: EN 175301-803	
Settings	Ordering code
1.2 bar ±10%	DE X 12 x A 50 P01
2.0 bar ±10%	DE X 20 x A 50 P01
5.0 bar ±10%	DE X 50 x A 50 P01
7.0 bar ±10%	DE X 70 x A 50 P01
9.5 bar ±10%	DE X 95 x A 50 P01

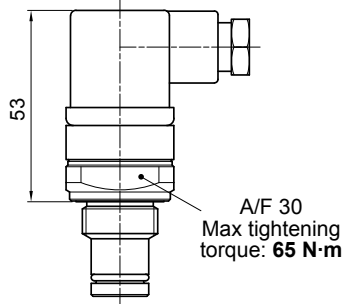

**Hydraulic symbol**

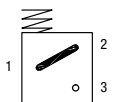

**Electrical symbol**

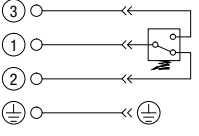

**Materials**

- Body: AISI 316L
- Base: Black polyamide
- Contacts: Silver
- Seal: HNBR - MFQ

**Technical data**

- Max working pressure: 420 bar
- Proof pressure: 630 bar
- Burst pressure: 1260 bar
- Working temperature: From -25 °C to +110 °C
- Compatibility with fluids: Mineral oils, Synthetic fluids  
HFB and HFC according to ISO 2943
- Degree protection: IP66 according to EN 60529  
IP69K according to ISO 20653

**Electrical data**

- Electrical connection: EN 175301-803
- Resistive load: 0.2 A / 115 Vdc

DEZ*50	
<b>Electrical Differential Pressure Indicator</b> Connection: EN 175301-803	
Settings	Ordering code
1.2 bar ±10%	DE Z 12 x A 50 P01
2.0 bar ±10%	DE Z 20 x A 50 P01
5.0 bar ±10%	DE Z 50 x A 50 P01
7.0 bar ±10%	DE Z 70 x A 50 P01
9.5 bar ±10%	DE Z 95 x A 50 P01

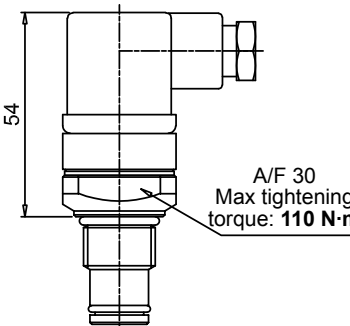

**Hydraulic symbol**

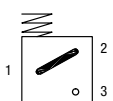

**Electrical symbol**

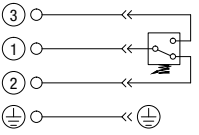

**Materials**

- Body: AISI 316L
- Base: Black polyamide
- Contacts: Silver
- Seal: HNBR - MFQ

**Technical data**

- Max working pressure: 700 bar
- Proof pressure: 1050 bar
- Burst pressure: 2100 bar
- Working temperature: From -25 °C to +110 °C
- Compatibility with fluids: Mineral oils, Synthetic fluids  
HFA, HFB, HFC according to ISO 2943
- Degree protection: IP66 according to EN 60529  
IP69K according to ISO 20653

**Electrical data**

- Electrical connection: EN 175301-803
- Resistive load: 0.2 A / 115 Vdc







# DIFFERENTIAL PRESSURE INDICATORS

## Dimensions

DTA*F70	
<b>Electronic Differential Pressure Indicator</b> Connection: IEC 61076-2-101 D (M12)	
Settings	Ordering code
1.2 bar ±10%	DT A 12 x F 70 P01
2.0 bar ±10%	DT A 20 x F 70 P01
5.0 bar ±10%	DT A 50 x F 70 P01
7.0 bar ±10%	DT A 70 x F 70 P01
9.5 bar ±10%	DT A 95 x F 70 P01

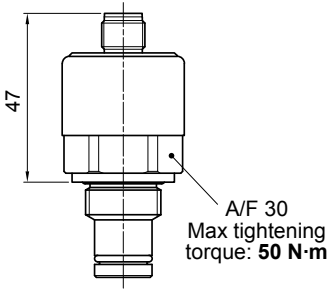

A/F 30  
Max tightening torque: **50 N·m**

**Hydraulic symbol**

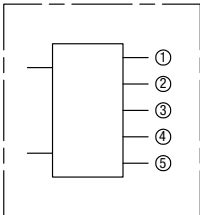

**Materials**

- Body: Brass
- Internal parts: Brass - Polyamide
- Contacts: Silver
- Seal: HNBR - FPM

**Technical data**

- Max working pressure: 420 bar
- Proof pressure: 630 bar
- Burst pressure: 1260 bar
- Compatibility with fluids: Mineral oils, Synthetic fluids  
HFB and HFC according to ISO 2943
- Degree protection: IP67 according to EN 60529

**Electrical data**

- Electrical connection: IEC 61076-2-101 D (M12)
- Power supply: 24 Vdc
- Analogue output: From 4 to 20 mA
- Thermal lockout: 30 °C (all output signals stalled up to 30 °C)

**Electrical symbol**

①	○	○	+24 Vdc
②	○	○	4 ÷ 20 mA
③	○	○	75% - N.O. Digital output
④	○	○	100% - N.O. Digital output
⑤	○	○	0 Vdc

DVA	
<b>Visual Differential Pressure Indicator</b>	
Settings	Ordering code
1.2 bar ±10%	DV A 12 x P01
2.0 bar ±10%	DV A 20 x P01
5.0 bar ±10%	DV A 50 x P01
7.0 bar ±10%	DV A 70 x P01
9.5 bar ±10%	DV A 95 x P01

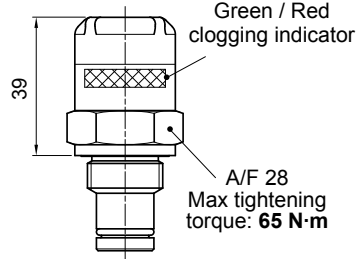

Green / Red  
clogging indicator

A/F 28  
Max tightening torque: **65 N·m**

**Hydraulic symbol**

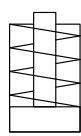

**Materials**

- Body: Brass
- Internal parts: Brass - Polyamide
- Seal: HNBR - FPM

**Technical data**

- Reset: Automatic reset
- Max working pressure: 420 bar
- Proof pressure: 630 bar
- Burst pressure: 1260 bar
- Working temperature: From -25 °C to +110 °C
- Compatibility with fluids: Mineral oils, Synthetic fluids  
HFB and HFC according to ISO 2943
- Degree protection: IP65 according to EN 60529

DVM	
<b>Visual Differential Pressure Indicator</b>	
Settings	Ordering code
1.2 bar ±10%	DV M 12 x P01
2.0 bar ±10%	DV M 20 x P01
5.0 bar ±10%	DV M 50 x P01
7.0 bar ±10%	DV M 70 x P01
9.5 bar ±10%	DV M 95 x P01

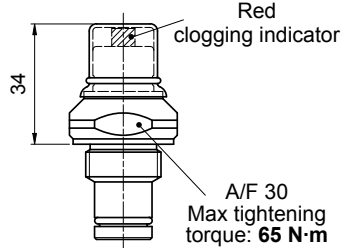

Red  
clogging indicator

A/F 30  
Max tightening torque: **65 N·m**

**Hydraulic symbol**

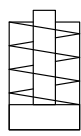

**Materials**

- Body: Brass
- Internal parts: Brass - Polyamide
- Seal: HNBR - FPM

**Technical data**

- Reset: Manual reset
- Max working pressure: 420 bar
- Proof pressure: 630 bar
- Burst pressure: 1260 bar
- Working temperature: From -25 °C to +110 °C
- Compatibility with fluids: Mineral oils, Synthetic fluids  
HFB and HFC according to ISO 2943
- Degree protection: IP65 according to EN 60529

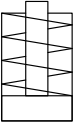
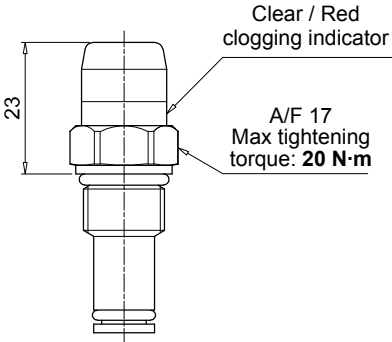
DVS		Hydraulic symbol	
<b>Visual Differential Pressure Indicator</b>			
Settings	Ordering code		
1.2 bar ±10%	DV S 12 H P01		
2.5 bar ±10%	DV S 25 H P01		
4.0 bar ±10%	DV S 40 H P01		
 <p style="text-align: center;">Clear / Red clogging indicator</p> <p style="text-align: center;">A/F 17 Max tightening torque: <b>20 N·m</b></p>		<p><b>Materials</b></p> <ul style="list-style-type: none"> <li>- Body: Brass</li> <li>- Internal parts: Brass - Polyamide</li> <li>- Seal: HNBR</li> </ul> <p><b>Technical data</b></p> <ul style="list-style-type: none"> <li>- Reset: Automatic reset</li> <li>- Max working pressure: 16 bar</li> <li>- Proof pressure: 24 bar</li> <li>- Burst pressure: 48 bar</li> <li>- Working temperature: From -25 °C to +110 °C</li> <li>- Compatibility with fluids: Mineral oils, Synthetic fluids HFB and HFC according to ISO 2943</li> <li>- Degree protection: IP67 according to EN 60529</li> </ul>	

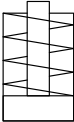
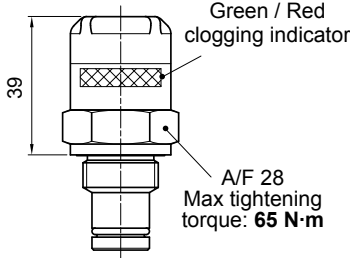
DVX		Hydraulic symbol	
<b>Visual Differential Pressure Indicator</b>			
Settings	Ordering code		
1.2 bar ±10%	DV X 12 x P01		
2.0 bar ±10%	DV X 20 x P01		
5.0 bar ±10%	DV X 50 x P01		
7.0 bar ±10%	DV X 70 x P01		
9.5 bar ±10%	DV X 95 x P01		
 <p style="text-align: center;">Green / Red clogging indicator</p> <p style="text-align: center;">A/F 28 Max tightening torque: <b>65 N·m</b></p>		<p><b>Materials</b></p> <ul style="list-style-type: none"> <li>- Body: AISI 316L</li> <li>- Internal parts: AISI 316L - Polyamide</li> <li>- Seal: HNBR - MFQ</li> </ul> <p><b>Technical data</b></p> <ul style="list-style-type: none"> <li>- Reset: Automatic reset</li> <li>- Max working pressure: 420 bar</li> <li>- Proof pressure: 630 bar</li> <li>- Burst pressure: 1260 bar</li> <li>- Working temperature: From -25 °C to +110 °C</li> <li>- Compatibility with fluids: Mineral oils, Synthetic fluids HFB and HFC according to ISO 2943</li> <li>- Degree protection: IP65 according to EN 60529</li> </ul>	

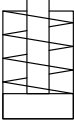
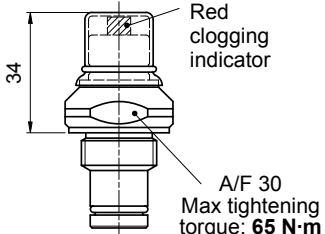
DVY		Hydraulic symbol	
<b>Visual Differential Pressure Indicator</b>			
Settings	Ordering code		
1.2 bar ±10%	DV Y 12 x P01		
2.0 bar ±10%	DV Y 20 x P01		
5.0 bar ±10%	DV Y 50 x P01		
7.0 bar ±10%	DV Y 70 x P01		
9.5 bar ±10%	DV Y 95 x P01		
 <p style="text-align: center;">Red clogging indicator</p> <p style="text-align: center;">A/F 30 Max tightening torque: <b>65 N·m</b></p>		<p><b>Materials</b></p> <ul style="list-style-type: none"> <li>- Body: AISI 316L</li> <li>- Internal parts: AISI 316L - Polyamide</li> <li>- Seal: HNBR - MFQ</li> </ul> <p><b>Technical data</b></p> <ul style="list-style-type: none"> <li>- Reset: Manual reset</li> <li>- Max working pressure: 420 bar</li> <li>- Proof pressure: 630 bar</li> <li>- Burst pressure: 1260 bar</li> <li>- Working temperature: From -25 °C to +110 °C</li> <li>- Compatibility with fluids: Mineral oils, Synthetic fluids HFB and HFC according to ISO 2943</li> <li>- Degree protection: IP65 according to EN 60529</li> </ul>	

# DIFFERENTIAL PRESSURE INDICATORS

## Dimensions

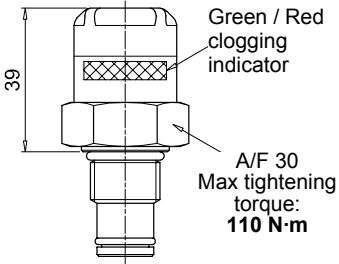
DVZ		Hydraulic symbol	Materials
<b>Visual Differential Pressure Indicator</b>			
Settings	Ordering code		
1.2 bar ±10%	DV Z 12 x P01		<b>Technical data</b> - Reset: Automatic reset - Max working pressure: 700 bar - Proof pressure: 1050 bar - Burst pressure: 2100 bar - Working temperature: From -25 °C to +110 °C - Compatibility with fluids: Mineral oils, Synthetic fluids HFB and HFC according to ISO 2943 - Degree protection: IP65 according to EN 60529
2.0 bar ±10%	DV Z 20 x P01		
5.0 bar ±10%	DV Z 50 x P01		
7.0 bar ±10%	DV Z 70 x P01		
9.5 bar ±10%	DV Z 95 x P01		

T2	
<b>Plug</b>	
Seal	Ordering code
HNBR	T2 H
FPM	T2 V

**Materials**

- Body: Phosphatized steel
- Seal: HNBR / FPM

A/F 30  
Max tightening torque: 50 N·m

T4	
<b>Plug</b>	
Seal	Ordering code
NBR	T4 A

**Materials**

- Body: Anodized aluminium
- Seal: NBR

A/F 19  
Max tightening torque: 20 N·m

X2	
<b>Stainless Steel plug 420 bar</b>	
Seal	Ordering code
HNBR	X2 H
FPM	X2 F
MFQ	X2 Q

**Materials**

- Body: AISI 316L
- Seal: HNBR / FPM / MFQ

A/F 30  
Max tightening torque: 50 N·m

X3	
<b>Stainless Steel plug 700 bar (only for FZH)</b>	
Seal	Ordering code
HNBR	X3 H
FPM	X3 F
MFQ	X3 Q

**Materials**

- Body: AISI 316L
- Seal: HNBR / FPM / MFQ

A/F 30  
Max tightening torque: 110 N·m



All data, details and words contained in this publication are provided for use by technically qualified personnel at their discretion, without warranty of any kind.

MP Filtri reserves the right to make modifications to the models and versions of the described products at any time for both technical and/or commercial reasons.

For updated information please visit our website: [www.mpfiltri.com](http://www.mpfiltri.com)

The colors and the pictures of the products are purely indicative.

Any reproduction, partial or total, of this document is strictly forbidden.

All rights are strictly reserved





# WORLDWIDE NETWORK

CANADA ♦ CHINA ♦ FRANCE ♦ GERMANY ♦ INDIA ♦ SINGAPORE  
UNITED ARAB EMIRATES ♦ UNITED KINGDOM ♦ USA



PASSION  PERFORM

in   



[mpfiltri.com](http://mpfiltri.com)

MP Filtri reserves the right to make modifications to the models and versions of the described products at any time for both technical and/or commercial reasons. For updated information please visit our website: [www.mpfiltri.com](http://www.mpfiltri.com). The colors and the pictures of the products are purely indicative. Any reproduction, partial or total, of this document is strictly forbidden. All rights are strictly reserved.

MF001000017  
EN - 2024.11